

# Installation Manual

## INTER-APPLIANCE COMMUNICATIONS

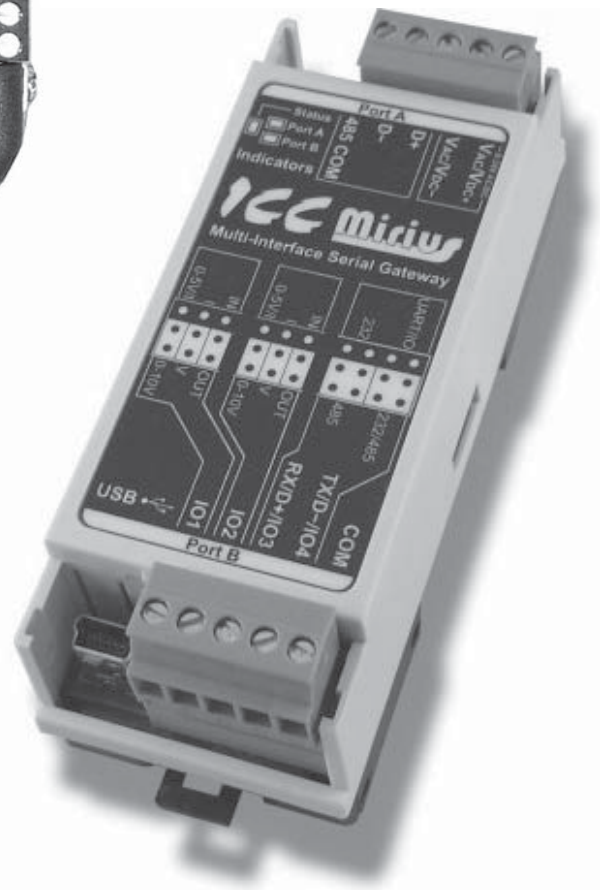
**Communication Node  
for EMS/BMS  
Control**



**Models**  
Ethernet (ETH-1000) for BACnet IP  
and Modbus TCP

**Serials**  
Mirius (Serial RS-485) for BACnet MS/TP  
and Modbus RTU

**Energy Management System  
Building Management System  
Installation**



# CONTENTS

INTRODUCTION .....	3	<i>Data Link Layer Options</i> .....	23
Warnings .....	3	<i>Device Address Binding</i> .....	23
Parts .....	3	<i>Networking Options</i> .....	23
Tools Required .....	3	<i>Character Sets</i> .....	23
General Guidelines .....	3	<i>Data Types</i> .....	24
FEATURES AND COMPONENTS .....	5	<i>Object Types and Property Support</i> .....	24
DEVICE CONFIGURATIONS .....	6	Device Object Listings .....	25
ETH-1000 Wiring .....	6	<i>Device Objects Initial Values</i> .....	25
Mirus Wiring .....	6	<i>Device Objects Minimum/Maximum Values</i> .....	25
INSTALLATION CONSIDERATIONS .....	8	<i>Central Control Board Major State Definitions</i> .....	29
Touch Screen Style Display Installation .....	8	<i>Energy Management System (EMS) Control</i> .....	29
High Efficiency Water Heater Installation – (BTH Or BTX Models) .....	8	<i>Fault Codes and Warnings</i> .....	29
Commercial Electric Water Heater (Touch Screen Installation) .....	8	BACnet / Boilers .....	31
Membrane Switch Style Display Installation .....	9	Product Description .....	31
High Efficiency Water heater Installation .....	9	Protocol Implementation Conformance Statement (PICS) .....	31
Commercial Electric Water heater Installation .....	10	<i>BACnet Standardized Device Profile (Annex L):</i> .....	31
Boiler Installation .....	11	<i>BACnet Boiler Interoperability</i> .....	31
XP XWH Boiler Installation .....	11	<i>Segmentation Capability:</i> .....	32
ECC DEVICE VERSIONS .....	12	<i>Data Link Layer Options</i> .....	32
BACnet / Gas Water Heaters .....	12	<i>Device Address Binding</i> .....	32
Product Description .....	12	<i>Character Sets</i> .....	32
Protocol Implementation Conformance Statement (PICS) .....	13	<i>Data Types Supported</i> .....	32
<i>BACnet Standardized Device Profile (Annex L):</i> .....	13	<i>Boiler Device Object Types/Property Support</i> .....	33
<i>BACnet Interoperability</i> .....	13	Object Listings .....	33
<i>Segmentation Capability</i> .....	13	<i>Boiler Device Object Initial Values</i> .....	33
<i>Data Link Layer Options</i> .....	13	<i>Boiler Device Object Min/Max Values</i> .....	34
<i>Device Address Binding</i> .....	13	<i>Boiler Slave States</i> .....	35
<i>Character Sets</i> .....	14	<i>Boiler Modbus Register Access</i> .....	35
<i>Data Types</i> .....	14	<i>Boiler Modulating Sensor Select/DHW Demand Switch</i> .....	36
<i>Object Types and Properties</i> .....	15	<i>Lock and Hold Codes</i> .....	36
Device Object Listings .....	15	Modbus / Gas Water Heaters .....	43
<i>Object Min/Max Values</i> .....	15	Product Description .....	43
<i>BACnet/Gas Water Heaters Object List</i> .....	16	Modbus Gas Water Heater Register Listings .....	43
<i>Central Control Board Major State Definitions</i> .....	19	<i>Modbus Gas Water Heater Register Properties</i> .....	43
<i>Xi 1.0 Energy Management System (EMS) Control</i> .....	19	<i>Central Control Board Major State Definitions</i> .....	46
<i>Mxi Energy Management System (EMS) Control</i> .....	20	<i>Xi 1.0 Energy Management System (EMS) Control</i> .....	46
<i>Fault Codes and Warnings</i> .....	21	<i>Mxi Energy Management System (EMS) Control</i> .....	46
BACnet / Electric Water Heaters .....	22	<i>Fault Codes and Warnings</i> .....	47
Product Description .....	22	Modbus / Electric Water Heaters .....	48
Protocol Implementation Conformance Statement (PICS) .....	22	Product Description .....	48
<i>BACnet Standardized Device Profile (Annex L):</i> .....	22	Electric Water Heater Register Listings .....	48
<i>BACnet Interoperability</i> .....	22	<i>Modbus Electric Water Heaters Register Properties</i> .....	48
		<i>Central Control Board Major State Definitions</i> .....	51
		<i>Energy Management System (EMS) Control</i> .....	51
		<i>Fault Codes and Warnings</i> .....	51
		ICC PROGRAM INFORMATION .....	52

# INTRODUCTION

New building construction and energy saving techniques have driven the need for improved communications between appliances and building environmental systems. There are several different protocols that have developed for accomplishing this task including BACnet and Modbus. Since appliances come with a variety of controls, interfacing with the various protocols presents different challenges.

Industrial Control Communications (ICC) has developed the devices to act as a communication gateway allowing appliances to communicate to the different building management protocols. The ICC module translates the appliance codes and commands into the appropriate protocol language giving the end user the ability to monitor and control the appliance. The end user will be able to adjust and monitor the equipment and obtain better levels of efficiency and cost savings.

The ICC module in this kit has been designed to seamlessly integrate with the water heater controls. Once the unit is connected to the control and to the energy management system, the user will be able to operate the unit with the Building Management system interface.

## WARNINGS

When installing the unit, ensure that all power is off before opening any water heater enclosure. Failure to do so could result in electrical shock and/or possible damage to the unit.

Do not install in areas of high temperature, in excess of 167° F. Install in areas not subject to water or excess moisture.

## PARTS

Table 1. Parts Required		
Item	Ethernet	Serial (RS-485)
ICC Module	X	X
Communication Cable	X	X
Power Adapter	X	X
Jumpers	4	4
Splitter	X	X
USB Key	X	X

## TOOLS REQUIRED

Wire Cutters

- 24 AWG Wire Stripper
- 2.5 mm Flat Blade Screw Driver

## GENERAL GUIDELINES

The module should be installed as close as practical to the water heater control.

The ICC module uses a 120 Volt power adapter to supply 9 volts DC for the unit. One 120 VAC outlet is required for each module installed. The power adapter comes with a six foot length of wire. If additional wire is needed, extra wire may be added, in accordance with local ordinances for installation of low voltage wire.

The ICC Gateway kit contains a USB key with the ICC Configuration Studio program, all configuration files, parameter lists and instructions required to install and configure to your water heater/boiler and BMS system.

Before plugging in the ICC Gateway, install the ICC Configuration Studio from the USB key and run the program. Once running, select File, Open Project and browse to the USB key and select the configuration file whose name matches the gateway,

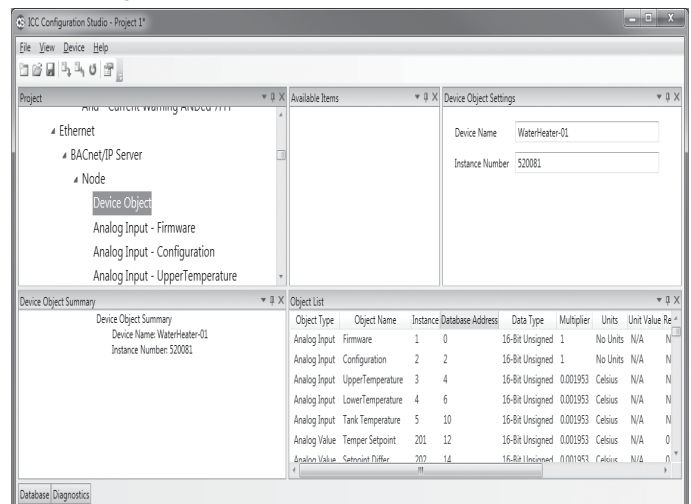
Because some USB hubs may not supply sufficient current to run the Gateway, insure that the ICC Gateway is connected to the power adapter. Then connect the ICC Gateway using the USB cable provided. Run the ICC Gateway Studio application from the start menu.

Each configuration has default address and BACnet instance settings that can be changed. For Mirius gateways, the default Modbus address is 1 and the default BACnet address is 81. For gas models the default BACnet Instance Number is 520081 and for electric models the default instance number is 530081. For Ethernet Gateways, the default setting is to acquire an IP address automatically from the router (DHCP). If a static IP address is desired this can also be set. To change these addresses and communication settings, use the ICC Configuration Studio application program. The latest version of this application program can be downloaded from:

[www.iccdesigns.com/icc-configuration-studio.html](http://www.iccdesigns.com/icc-configuration-studio.html)

Before making any changes, it is recommended to save the installed configuration project using the disk icon or *File -> Save Project As*, then give it a name and select the folder, finally press *Save*.

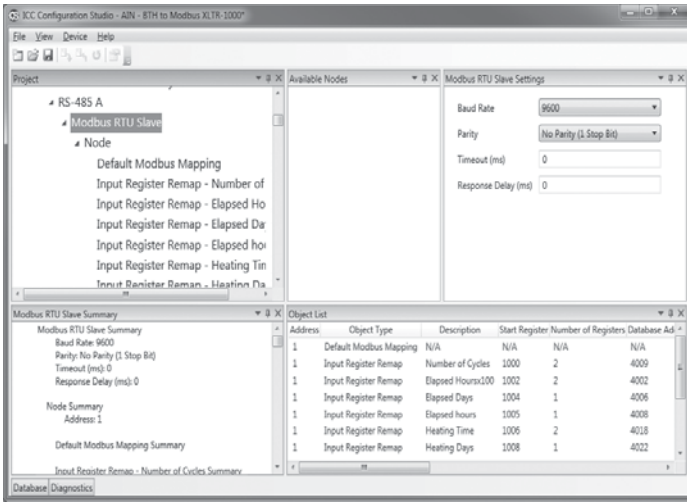
To change the Instance number and the Device Name, scroll down and select the Device Object and replace the text in the boxes in the upper right corner.



**Figure 1. Changing Instance Number and Device Name**

For ETH-1000 (Ethernet interface) the IP settings, including DHCP/Static, the IP address and authentication can be changed by selecting Ethernet from the upper left hand window and changing the text and drop down list selection similar to changing the Instance number above.

For Mirius (RS-485 A interface for BACnet MS/TP or ModBus RTU), the baud rate and other serial communication parameters can be changed by scrolling down to and selecting *RS-485 A -> ModBus RTU Slave*.



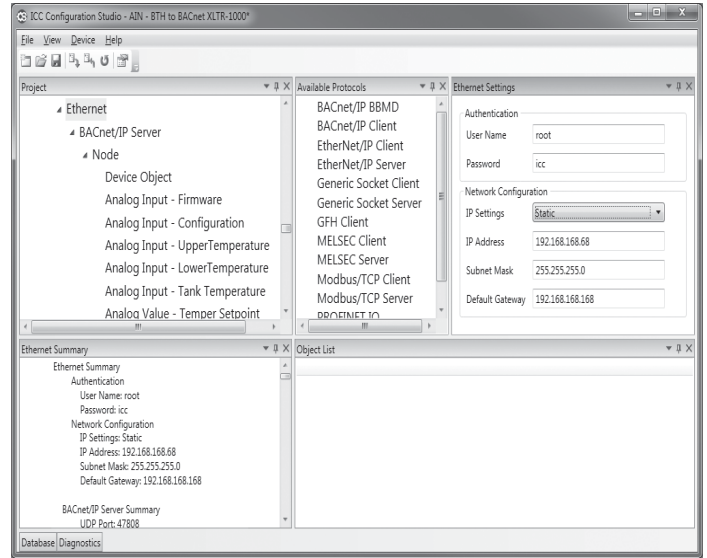
**Figure 2. Changing ModBus Parameters**

The ModBus address can be changed by selecting Node under the RS-485 A -> ModBus RTU item.

Likewise for BACnet, the baud rate and other serial communication parameters can be changed by scrolling down to and selecting RS-485 -> BACnet MS/TP Server. The BACnet MAC Address can be changed by selecting Node under the RS-485 A->BACnet MS/TP Server.

**Warning:** Do not change any other values other than these or the gateway configuration may not function properly. In this case, the file saved above can be reloaded to start over.

When changes are complete press the **Download Configuration** icon:



**Figure 3. Changing BACnet Parameters**

# FEATURES AND COMPONENTS



Figure 4. ICC ETH-1000 (Ethernet) Version



Figure 5. ICC Merius Serial RS-485 Version

- Works with Cyclone (BTH, BTHL, BTX-100, BTXL-100), McBee DVE, DSE/DVE/DHE.
- Works with Ultra Force, SUF, SUFL, SHE, SEV/SEH, SSE and CSB-1FE.
- Use the ICC Control to enable/disable the water heater.
- Change Temperature Set points and differentials.
- Two models with four different configurations to connect to BACnet and Modbus.
- Ethernet and Serial RS-485 versions available.
- Two-wire RS-485 versions available.
- Power can be supplied via the USB cable, as a 7-24 VDC input on the main terminal block, or via IEEE 802.3af Power over Ethernet (PoE on ETH-1000 only).
- Configure protocols, network characteristics, and client/server object definitions.
- Graphically interact with the internal database in real-time via the USB connection.
- Automatically discover and configure IP settings Ethernet gateways connected to the current subnet.
- Update firmware.

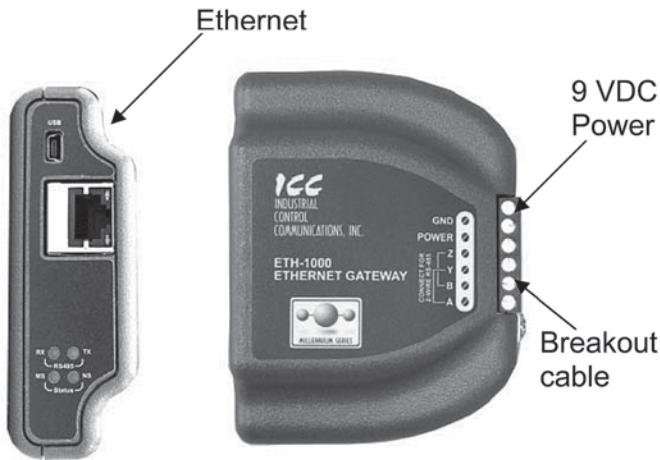
Table 2. ICC Versions		
Kit	Connection	Part Number
Mirius	Serial - RS485 (RTU/MS/TP)	100316044
ETH-1000	Ethernet - RJ-45	100316045



# DEVICE CONFIGURATIONS

## ETH-1000 WIRING

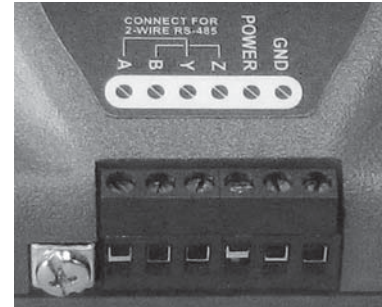
**Figure 6** shows the standard configuration of the Ethernet modules. The module has connections for 9 VDC power, three wire connections for the communication breakout cable, and a port for the connection of the EMS system through Ethernet RJ-45 cable communications.



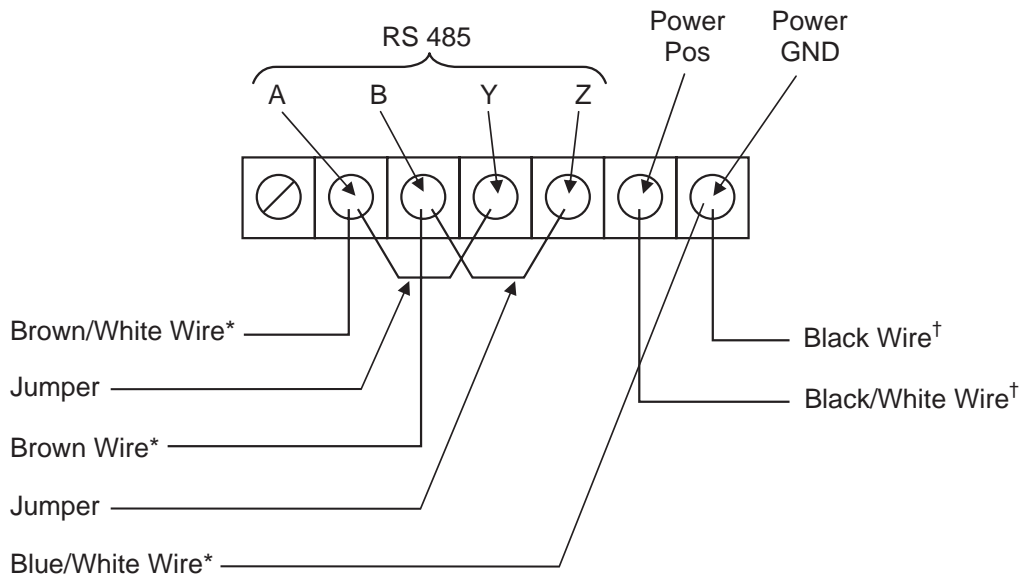
**Figure 6. Standard Configuration for Ethernet Modules**

Connecting of the power adapter and the boiler or water heater communication cable to the module is accomplished on the same end of the unit. **Figure 7** is a close up of the connection terminal and **Figure 8** shows the appropriate connection to the strip using the power adapter and communication cable.

The provided communication cable has two RJ-45 plugs. Remove one with a wire cutter, then locate and strip the 3 wires described below and strip 1/2 inch of insulation before connecting.



**Figure 7. Connecting the Power Adapter**



\*From Communication Cable

†From 9 VDC Power Adapter Cable

**Figure 8. Connections from the Communications and Power Adapter Cables**

The connections in **Figure 8** are the same regardless of the appliance or the communication protocol.

At the opposite end of the module is the connection location for the EMS LAN connection. The EMS uses an Ethernet connection with an RJ-45 connector. Plug the cable into the RJ-45 receptacle.

For more information on connecting the ICC Gateway to your Building Management System, please refer to the User Manual provided on the enclosed USB key in the “Documents” folder. The two applicable documents will be found in the Manuals.

## MIRIUS WIRING

**Figure 9** shows the standard configuration of the module. Port A of the module has connections for 9 VDC power and serial communications for EMS/BMS (BACnet or Modbus). Port B has connections for the communication (breakout) cable for serial communications to the water heater/boiler.

**Figure 10** is a close up of the connection terminal and **Figure 11** shows the appropriate connection to the strip using the power adapter and EMS/BMS communication cable.



Figure 9. Mirius Unit with Communications Terminal

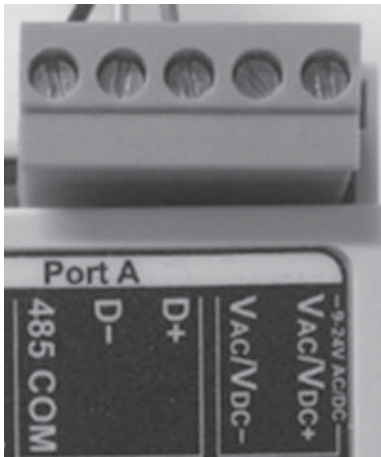


Figure 10. Mirius Port A Terminal

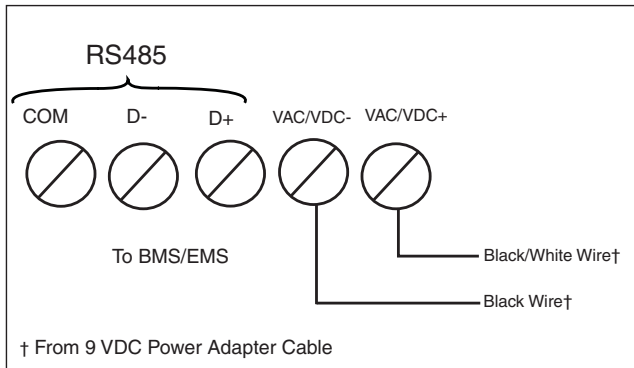


Figure 11. Port A Connection Diagram

The connections in **Figure 11** are the same regardless of the appliance or the communication protocol.

Port A of the module is the connection location for the EMS/BMS connection. See **Figure 10**. For connections to the terminal use the labeling on the module as a guide.

When connecting the RS-485A connections (BACnet or Modbus) please note the following:

- Only 2-wire systems are supported
- Connect the RX/TX+ (plus) wire from your Building Management System to terminal D+. Connect the RX/TX- (minus) wire from your Building Management System to terminal D-.

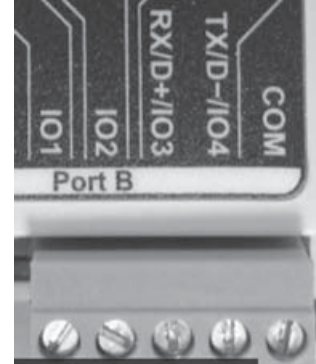


Figure 12. Close-Up View of Connection Terminal

Port B of the module is the connection for the water heater/boiler connection. See **Figure 12** for the connection to the terminal. Use the labeling on the module as a guide.

The provided communication cable has two RJ-45 plugs. Remove one with a wire cutter, then locate and strip the 3 wires described below and strip 1/2 inch of insulation before connecting.

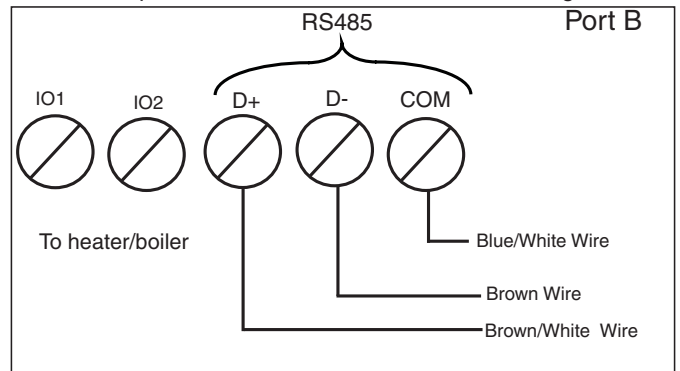


Figure 13. Port B Connection Diagram

# INSTALLATION CONSIDERATIONS

There are two types of displays to consider when installing the ICC gateway modules to the water heaters, the older type with membrane switches and the newer style with a touch screen. The new touch screen style display does not need the provided RJ-485 splitter and it can be discarded.

## TOUCH SCREEN STYLE DISPLAY INSTALLATION

### HIGH EFFICIENCY WATER HEATER INSTALLATION – (BTH OR BTX MODELS)

Follow the directions under general guidelines for connecting the module to the Energy Management System and power. This section will guide the installer on how to mount and connect the module to the water heater. The control box and mounting location on the water heater is on the top of the unit behind the display module. See *Figure 14*.

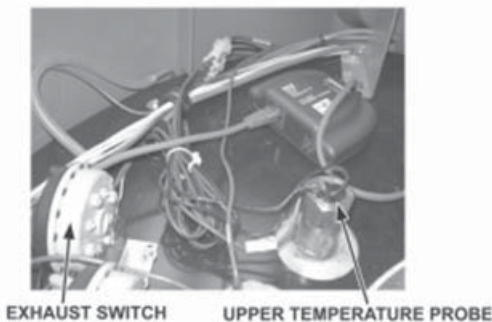
Connection of the RJ-45 end of the communication cable to the heater is required to plug into J13 of the control board inside the “black controls box” (for newer models) requiring removal of two screws holding the lid on. After plugging in the communications cable, route the cable to the bottom side with the other cables and put the lid back on with the two screws.



**Figure 14. Controller Location (BTH or BTX models)**

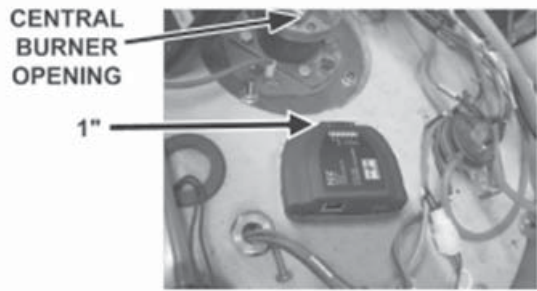
Removal of the top is not required, but it may be helpful to remove the control box lid. Use a ladder to access the top of taller water heaters.

Next locate the upper temperature probe and exhaust switch. Position the module between the two about 1 inch from the central burner opening. For the 500 MBTUH Model this would be next to the upper temperature probe.



**Figure 15. Location of Exhaust Switch and Upper Temperature Probe**

Connect the three wires from the end of the communication cable to the module in Accordance with page 4. Once the unit is installed and connected, the building management system can be connected to the appropriate connection point on the module.



**Figure 16. Clearance of ICC Unit from Central Burner Opening**

### COMMERCIAL ELECTRIC WATER HEATER (TOUCH SCREEN INSTALLATION)

Normally the commercial electric heaters have a display with membrane switches, but may have had a replacement touch screen or future models may one day include touch screens. If this heater has membrane switches on the bottom and right of the display, then see the section below COMMERCIAL ELECTRIC WATER HEATER INSTALLATION.

Follow directions under general guidance for connecting module to the Energy Management System and power. This section will guide the installer on how to mount and connect the module to the water heater.

The module should be located where it will not interfere with the door or in a location that is acceptable to the customer. Care should be exercised to avoid drilling the self-tapping screws into electrical or sensitive components. Electrical power should be disconnected before proceeding with ICC installation.

Using a flat blade screwdriver, loosen the screws holding the door of the unit. See Figure B1. Swing the door to the open position and locate the control board.



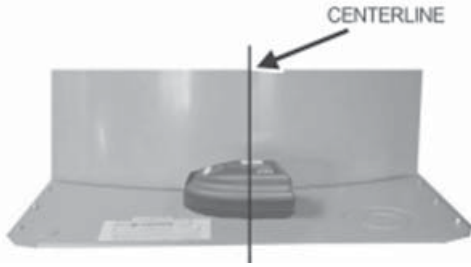
**Figure 17. Opening the Control Board Compartment Door**

Locate the module on the top of the door cabinet approximately 1 inch from the water heater jacket and on the centerline of the unit (See *Figure 18* and *Figure 19*).



**Figure 18. ICC Location Relative to Water Heater Jacket**





**Figure 19. ICC Location Relative to Centerline**

Remove the hole plug from the 0.875" knockout on the left corner of the top panel. See **Figure 20**.

Plug the communications cable into D9 and run the three wire connection up through the knockout and connect the three wires to the module as shown on page 4. Once the unit is installed and connected, the building management system can be connected to the appropriate connection point on the module.



**Figure 20. Location of Communications Wiring Knockout**

## MEMBRANE SWITCH STYLE DISPLAY INSTALLATION

### HIGH EFFICIENCY WATER HEATER INSTALLATION

Follow the directions under general guidelines for connecting the module to the Energy Management System and power. This section will guide the installer on how to mount and connect the module to the water heater.

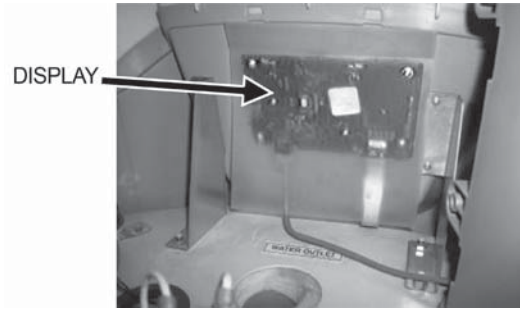
The control box and mounting location on the water heater is on the top of the unit behind the display module. See **Figure 21**.



**Figure 21. Locating the Control Box**

Removal of the top is not required. Use a ladder to access the top of taller water heaters. Locate the back of the display as shown in **Figure 22**. Disconnect the RJ45 plug from the display and connect the RJ45 plug from the split communication cord into the display receptacle. Plug the display communication cord back into the receptacle on the split communication cord as shown in **Figure 23**.

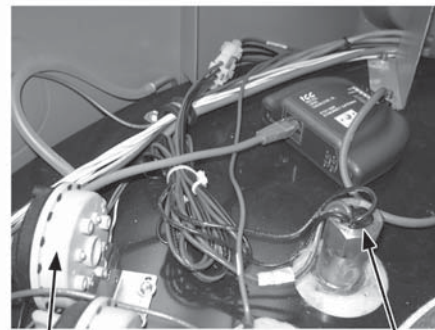
Plug the supplied wiring harness with the gateway controller into the remaining open RJ45 port on the Split Communication cord.



**Figure 22. Locating the Back of the Display**

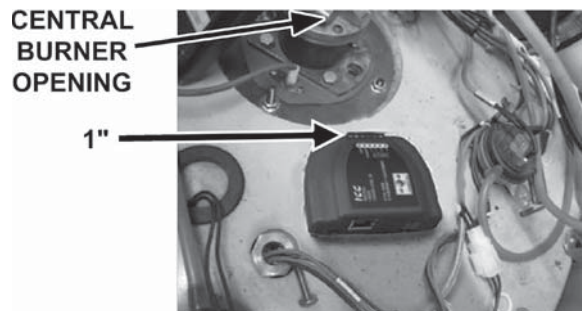


**Figure 23. Reconnecting the Communication cord to the Receptacle**  
Next locate the upper temperature probe and exhaust switch. See **Figure 24**. Position the module between the two about 1 inch from the central burner opening. See **Figure 25**. For the 500 MBTUH model this would be next to the upper temperature probe.



**EXHAUST SWITCH      UPPER TEMPERATURE PROBE**

**Figure 24. Locating Upper Temperature Probe and Exhaust Switch**



**Figure 25. Connecting the Communications Cable to the Module**  
Connect the three wires from the end of the communication cable to the module in accordance with **Figure 25**. Once the unit is installed and connected, the building management system can be connected to the appropriate connection point on the module.

## COMMERCIAL ELECTRIC WATER HEATER INSTALLATION

Follow directions in *Device Configurations* (page 6) for connecting the module to the Energy Management System and power. This section will guide the installer on how to mount and connect the module to the water heater.

The module should be located where it will not interfere with the door or in a location that is acceptable to the customer. Care should be exercised to avoid drilling the self tapping screws into electrical or sensitive components. Electrical power should be disconnected before proceeding with ICC installation.

Using a flat blade screwdriver, loosen the screws holding the door of the unit. See *Figure 26*.

Swing the door to the open position and locate the back of the display module. See *Figure 27*.



**Figure 26. Loosening the Screws to the Door of the Unit**

Unplug the display communication cable from the display. Plug the RJ45 plug from the split communication cable into the back of the display. See *Figure 28*.

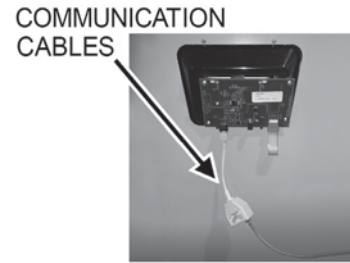
Plug the display cable into the split cable receptacle as shown in *Figure 29*. Plug the supplied wiring harness with the gateway controller into the remaining open RJ45 port on the Split Communication cable (Not shown).



**Figure 27. Locating the Communications Cable on Back of the Display**



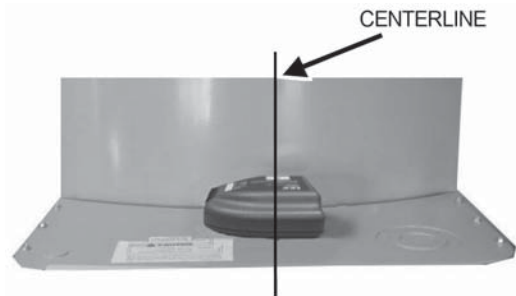
**Figure 28. Reconnecting RJ45 Plug from Split Communication Cable**



**Figure 29. Connecting the Display Cable to Split Cable Receptacle**  
Locate the module on the top of the door cabinet approximately 1 inch from the water heater jacket and on the centerline of the unit (See *Figure 30* and *Figure 31*).



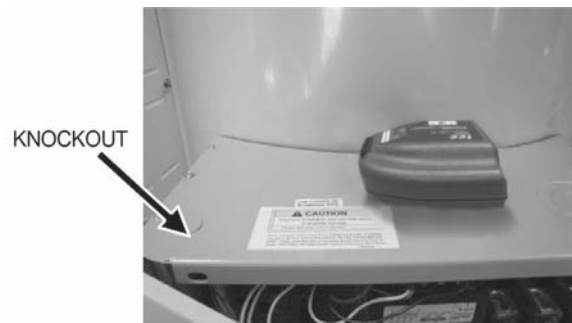
**Figure 30. Locating the Module**



**Figure 31. Module Location Relative to Centerline**

Remove the hole plug from the 0.875" knockout on the left corner of the top panel. See *Figure 32*.

Run the three wire connection from the split cable up and through the knockout and connect the three wires to the module as shown on page 4. Once the unit is installed and connected, the building management system can be connected to the appropriate connection point on the module.



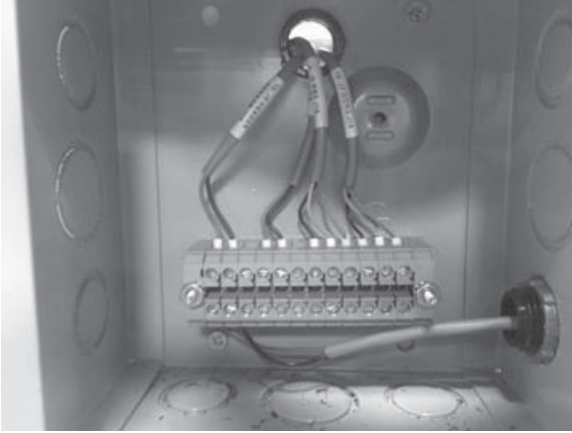
**Figure 32. Knockout on Left Corner of Top Panel**

## BOILER INSTALLATION

### XP XWH BOILER INSTALLATION

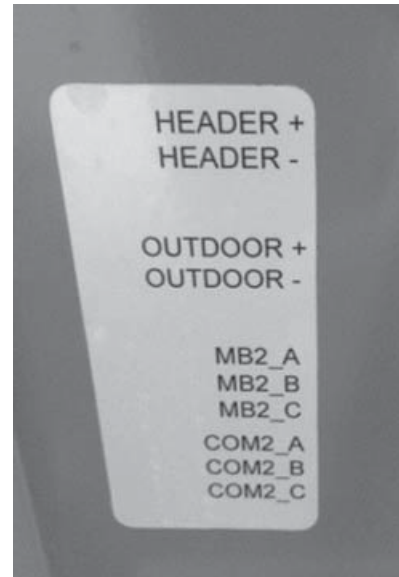
Follow directions under general guidance for connecting module to the Energy Management System and power. This section will guide the installer on how to mount and connect the module to the boiler.

Open the door on the low voltage wiring box on the back side of the heater to see the terminal strip where to connect the gateway to the boiler as shown in **Figure 33**



**Figure 33. Boiler Terminal Strip**

Inside the cover of the box shows the wiring legend for the terminal strip (see **Figure 34**).



**Figure 34. Terminal Strip Wiring Legend**

Place the Gateway on top of the heater or conveniently nearby.

Locate a knock out on the right side of the low voltage box to run the communication cable through to the inside of the low voltage box.

The boiler does not have an RJ-45 connector as do the water heaters to connect Port A of the gateway, so the plug on the other end of the communications cable must also be cut off with a wire cutter. Locate and strip the insulation 1/2 inch from the brown, brown/white and blue/white wires. Connect the brown/white wire to COM2\_A, the brown wire to COM2\_B, and the blue/white wire to COM2\_C.

## ECC DEVICE VERSIONS

Two versions of the ECC are available as follows:

<b>Product:</b>	ICC Gateway (for use with Xi™ and MXi™ Gas Water Heaters)
<b>Product Model Number:</b>	<ul style="list-style-type: none"> <li>• 100316044 (Mirus for BACnet MT/TP)</li> <li>• 100316045 (ETH-1000 for BACnet IP)</li> </ul>
<b>Product Version:</b>	V3.000 (Mirus) or V4.001 or greater (ETH-1000)
<b>BACnet Protocol Revision:</b>	12 (135-2010)

The following sections describe the ECC communications characteristics available with each of the following types of water heaters:

- BACnet/Gas
- BACnet/Electric
- BACnet/Boilers
- ModBus/Gas
- ModBus/Electric

## BACNET / GAS WATER HEATERS

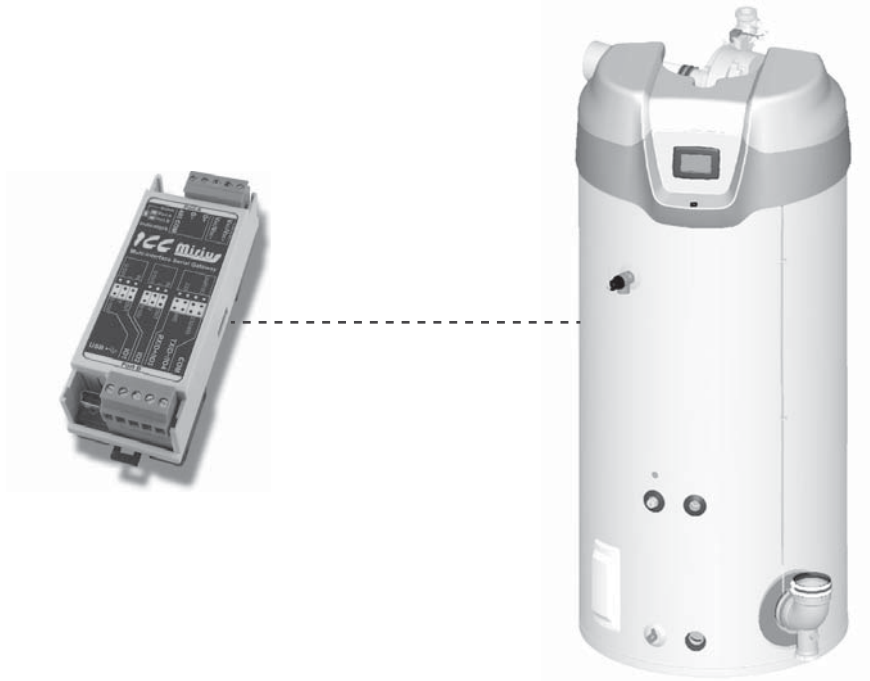


Figure 35. yclone Xi Gas Water Heaters (Virtual BACnet device via ICC Gateway)

### PRODUCT DESCRIPTION

The Mirus is a multiprotocol RS-485 to RS-485 gateway. The ETH-1000 is an Ethernet to RS-485 multiprotocol gateway. These products supports native BACnet, connecting directly to IP or the MS/TP LAN using baud rates of 4800, 9600, 19200, 38400, 57600, 76800, and 115200. As shipped the devices are configured as a BACnet Server.

All Xi™ MXi™ controls provide communications via propriety protocol with the ICC Gateway. The Mirus supports BACnet MS/TP communications and the ETH-1000 supports BACnet/IP to access data available at the display plus control of a limited number of points such as Operating Setpoint.



**PROTOCOL IMPLEMENTATION CONFORMANCE STATEMENT (PICS)**

**BACnet Standardized Device Profile (Annex L):**

BACnet Application Specific Controller (B-ASC)

**BACnet Interoperability**

<b>Table 3. BACnet Interoperability Building Blocks Supported (Annex K):</b>	
Data Sharing - ReadProperty-A (DS-RP-A)	<input checked="" type="checkbox"/>
Data Sharing - ReadProperty-B (DS-RP-B)	<input checked="" type="checkbox"/>
Data Sharing - ReadPropertyMultiple-B (DS-RPM-B)	<input checked="" type="checkbox"/>
Data Sharing - WriteProperty-A (DS-WP-A)	<input checked="" type="checkbox"/>
Data Sharing - WriteProperty-B (DS-WP-B)	<input checked="" type="checkbox"/>
Data Sharing - WritePropertyMultiple-B (DS-WPM-B)	<input checked="" type="checkbox"/>
Data Sharing – COV-B (DS-COV-B) (BACnet/IP only)	<input checked="" type="checkbox"/>
Device Management-Dynamic Device Binding-A (DM-DDB-A)	<input checked="" type="checkbox"/>
Device Management-Dynamic Device Binding-B (DM-DDB-B)	<input checked="" type="checkbox"/>
Device Management-Dynamic Object Binding-B (DM-DOB-B)	<input checked="" type="checkbox"/>
Device Management-Device Communication Control-B (DM-DCC-B)	<input checked="" type="checkbox"/>
Device Management – ReinitializeDevice-B (DM-RD-B)	<input checked="" type="checkbox"/>

**Segmentation Capability**

Segmentation not supported.

**Data Link Layer Options**

<b>Table 4. Data Link Layer Options</b>	
BACnet IP (Annex J) (ETH-1000 only)	<input checked="" type="checkbox"/>
BACnet IP (Annex J), Foreign Device (ETH-1000 only)	<input checked="" type="checkbox"/>
ANSI/ATA 878.1, 2.5Mb. ARCNET (Clause 8)	<input type="checkbox"/>
ANSI/ATA 878.1, RS-485. ARCNET (Clause 8), baud rates() _____	<input type="checkbox"/>
MS/TP master (Clause9) baud rate(s): 4800, 19200, 38400, 57600, 76800, 115200	<input checked="" type="checkbox"/>
MS/TP slave (Clause9) baud rate(s): _____	<input type="checkbox"/>
Point-To-Point, EIA 232 (Clause 10), baud rate(s): _____	<input type="checkbox"/>
Point-To-Point, modem (Clause 10), baud rate(s): _____	<input type="checkbox"/>
LonTalk, (Clause 11), medium _____	<input type="checkbox"/>
Other: _____	<input type="checkbox"/>

**Device Address Binding**

Is static device binding supported? (This is currently for two-way communications with MS/TP slaves and certain other devices.) YES

**Networking Options**

<b>Table 5. Networking Options</b>	
Router, Clause 6 – List all routing configurations	<input type="checkbox"/>
Annex H, BACnet Tunneling Router over IP	<input type="checkbox"/>
BACnet/IP Broadcast Management Device (BBMD). Does the BBMD support registrations by Foreign Devices? (ETH-1000 only)	<input checked="" type="checkbox"/>

**Character Sets**

<b>Table 6. Character Sets Supported</b>	
ANSI X3.4	<input checked="" type="checkbox"/>
IBM™ /Microsoft™ DBCS	<input type="checkbox"/>
ISO 8859-1	<input type="checkbox"/>
ISO 10646 (UCS-2)	<input type="checkbox"/>
ISO 10646 (UCS-4)	<input type="checkbox"/>
JIS C 6226	<input type="checkbox"/>

**Data Types**

The following table summarizes the data types that are accepted (in the case of a write property service) and returned (in the case of a read property service) when targeting the present value property of each supported object type.

<b>Table 7. Data Types Supported</b>		
<b>Object Type</b>	<b>Service</b>	
	<b>Read Property</b>	<b>Write Property</b>
Analog Output Analog Value	Real	Real, Unsigned, Integer, Null
Analog Input	Real	N/A
Binary Output Binary Value	Enumerated	Enumerated, Boolean, Real, Unsigned, Integer, Null
Binary Input	Enumerated	N/A
Multi-state Output Multi-state Value	Unsigned	Real, Enumerated, Unsigned, Integer, Null
Multi-state Input	Unsigned	N/A

Object Types and Properties

Table 8. Object Types/Property Support Table										
Property	Device	Binary Input	Binary Output	Binary Value	Analog Input	Analog Output	Analog Value	Multi Input	Multi Output	Multi Value
Object Identifier	R	R	R	R	R	R	R	R	R	R
Object Name	R	R	R	R	R	R	R	R	R	R
Object Type	R	R	R	R	R	R	R	R	R	R
System Status	R									
Vendor Name	R									
Vendor Identifier	R									
Model Name	R									
Firmware Revision	R									
App S/W Revision	R									
Protocol Revision	R									
Services Supported	R									
Object Types Supported	R									
Object List	R									
Max APDU Length	R									
Segmentation Support	R									
APDU Timeout	R									
Number APDU Retries	R									
Max master	R									
Max Info Frames	R									
Device Address Binding	R									
Database Revision	R									
Present Value	R	W	W	R	W	W	R	W	W	
Status Flags	R	R	R	R	R	R	R	R	R	
Event State	R	R	R	R	R	R	R	R	R	
Out-of Service	R	R	R	R	R	R	R	R	R	
Units	R	R	R	R	R	R				
Priority Array	R	R	R	R	R					
Relinquish Default	R	R	R	R	R					
Polarity	R	R								
Inactive Text	R	R								
Active Text	R	R								

R - readable using BACnet services  
W - readable and writable using BACnet services

DEVICE OBJECT LISTINGS

Object Min/Max Values

**Note:** Point listings have been changed completely from earlier versions of this listing.

Table 9. Device Object					
Property Name	ID	BACnet Data Type	RW	Initial Value (Mirus)	Initial Value (ETH-1000)
Object_Identifier	75	Object Identifier	RW	Device, 520081	Device, 520081
Object_Name	77	Character String	RW	Water Heater-01	Water Heater-01
Object_Type	79	Enumerated	R	Device	Device
System_Status	112		R	Operational	Operational

**BACnet / Gas Water Heaters**

Table 9. Device Object					
Property Name	ID	BACnet Data Type	RW	Initial Value (Mirius)	Initial Value (ETH-1000)
Vendor_Name	121		R	ICC, Inc.	ICC, Inc.
Vendor_Identifier	120		R	242	242
Model_Name	70		R	Mirius	ETH-1000
Firmware_Revision	44	Character String	R	V3.300	V4.002
Application_Software_Version	12		R	V3.300	V4.002
Protocol_Version	98		R	1	
Protocol_Revision	139		R	2	
Protocol_Services_Supported	97		R	See PICS	
Protocol_Object_Types_Supported	96		R	AI, AO, AV, BI, BO, BV, MSI, MSO, MSV	AI, AO, AV, BI, BO, BV, MSI, MSO, MSV
Object_List	76		R	See Table	See Table
Max_APDU_Length_Accepted	62		R	480	1444
Segmentation_Supported	107		R	3	3
APDU_Timeout	10		RW	1000ms	1000ms
Number_Of_APDU_Retries	73		R	3	3
Max_Master	64		RW	127	Unsupported
Device_Address_Binding	30		R	{}	{}
Local_Date	56		R	Unsupported	Unsupported
Local_Time	57		R	Unsupported	Unsupported

**BACnet/Gas Water Heaters Object List**

- Not all models support all registers. Also parameter names may be different than shown here on some models.
- This table may be subject to change in the future.
- Adjustable objects are in bold and indicated by “W” (writable).

Table 10. BACnet/Gas Water Heaters Object List								
BACnet Object Name (Description)	BACnet Object Type/Inst.	BACnet Object Property	R/W	Units	Min Value (if W)	Max Value (if W)	Xi 1.0	Mxi
Firmware Ver-Rev <sup>1</sup> (Firmware Version)	Analog Input 1	Present_Value	R				✓	✓
Configuration	Analog Input 2	Present_Value	R				✓	✓
Upper Temperature (Upper or Primary Temperature)	Analog Input 3	Present_Value	R	°C			✓	✓
Lower Temperature (Lower or Secondary Temperature)	Analog Input 4	Present_Value	R	°C			✓	✓
Tank Temperature (Controlling Tank Temperature algorithmically calculated)	Analog Input 5	Present_Value	R	°C			✓	✓
<b>Temper Setpoint</b> (Desired Tank Temperature)	Analog Value 201	Present_Value	R/W	°C (°F)	32.2 (90)	82.2 (180)	✓	✓
<b>SetPoint Differ</b> (Setpoint Differential)	Analog Value 202	Present_Value	R/W	°C (°F)	1.1 (2)	11.1 (20)	✓	✓

1. Data is encoded into the 16 bits as major revision (upper 8 bits) and minor revision (lower 8 bits).  
 2. Not recommended for use currently as UIM does not currently support and warning will come up as “Unknown.”



**BACnet / Gas Water Heaters**

**Table 10. BACnet/Gas Water Heaters Object List**

<b>BACnet Object Name (Description)</b>	<b>BACnet Object Type/Inst.</b>	<b>BACnet Object Property</b>	<b>R/W</b>	<b>Units</b>	<b>Min Value (if W)</b>	<b>Max Value (if W)</b>	<b>Xi 1.0</b>	<b>Mxi</b>
<b>Mxi Mod% Cmd</b> Commands Modulation % (0%=minimum heat, 100%=rated heat). Note: It is really an upper limit. If heater wants to command less it will.	Analog Value 207	Present_Value	R/W	%	0	100		✓
<b>MxiLowTempAlrmSP<sup>2</sup></b> (Low Temperature Alarm)	Analog Value 208	Present_Value	R/W	°C (°F)	32.2 (90)	82.2 (180)		✓
Number of Cycles (Number of heating cycles)	Analog Value 209	Present_Value	R				✓	✓
Elapsed Time (Time heater has been powered up in Hours with two place beyond the decimal)	Analog Value 210	Present_Value	R	Hours with two places beyond the decimal.			✓	✓
Elapsed Days (The number of days that the heater has been powered up)	Analog Value 211	Present_Value	R	Days			✓	✓
Elapsed Hours (The hours portion that the heater has been powered up. Use with Elapsed Days)	Analog Value 212	Present_Value	R	Hours			✓	✓
Heating Time (Time heater has been actually heating water in Hours with two place beyond the decimal)	Analog Value 213	Present_Value	R	Hours with two places beyond the decimal.			✓	✓
Heating Days (The amount of time in number of days heater has been actually heating water)	Analog Value 214	Present_Value	R	Days			✓	✓
Heating Hours (The hours portion of the amount of time heater has been actually heating water. Use with Heating Days)	Analog Value 215	Present_Value	R	Hours			✓	✓
IgniterCurrent (Hot Surface Igniter current in amps)	Analog Value 216	Present_Value	R	Amps			✓	✓
#CCB HW Faults (CCB Hardware Fault Counter)	Analog Value 217	Present_Value	R				✓	✓
#Model Faults (Model Fault Counter)	Analog Value 218	Present_Value	R				✓	✓
#Upper Temp Faults (Upper Temperature Probe Fault Counter)	Analog Value 219	Present_Value	R				✓	
#Lower Temp Faults (Lower Temperature Probe Fault Counter)	Analog Value 220	Present_Value	R				✓	✓
#Flame Probe Flt (Flame Probe Fault Counter)	Analog Value 221	Present_Value	R				✓	✓
#Flame Status Flt (Flame detect or not detected at proper time Fault Counter)	Analog Value 222	Present_Value	R				✓	✓
#CCB Comm Faults (Communication Fault Counter)	Analog Value 223	Present_Value	R				✓	✓
#ECO Faults (High temperature Energy Cut Off switch in Upper temperature probe Fault Counter)	Analog Value 224	Present_Value	R				✓	✓
#LowGasPress Flt (Low Gas Pressure switch Fault Counter)	Analog Value 225	Present_Value	R				✓	✓
#Blocked In Flts (Blocked Inlet pressure switch Fault Counter)	Analog Value 226	Present_Value	R				✓	✓
#Blocked Exhst Flt (Blocked Exhaust Pressure & Condensate switch Fault Counter)	Analog Value 227	Present_Value	R				✓	✓
#Ext Vent Faults (External Vent Fault Counter)	Analog Value 228	Present_Value	R				✓	
#Blower Prv Flts (Blower Prove Pressure Switch Fault Counter)	Analog Value 229	Present_Value	R				✓	✓
#Igniter Faults (Igniter Fault Counter)	Analog Value 230	Present_Value	R				✓	

1. Data is encoded into the 16 bits as major revision (upper 8 bits) and minor revision (lower 8 bits).
2. Not recommended for use currently as UIM does not currently support and warning will come up as "Unknown."

## BACnet / Gas Water Heaters

**Table 10. BACnet/Gas Water Heaters Object List**

BACnet Object Name (Description)	BACnet Object Type/Inst.	BACnet Object Property	R/W	Units	Min Value (if W)	Max Value (if W)	Xi 1.0	Mxi
#Ignition Failure (Ignition Failure Fault Counter)	Analog Value 231	Present_Value	R				✓	✓
#Powr Supply Flt (Power Supply Fault Counter)	Analog Value 232	Present_Value	R				✓	✓
#Powr Anode Flts (Powered Anode Alert Counter)	Analog Value 233	Present_Value	R				✓	✓
<b>EMS Mode-Status</b>	Analog Value 263	Present_Value	R/W	Xi 1.0 see table 3			✓	✓
Upper Temp Open (Upper temperature Probe open status)	Binary Input 301	Present_Value	R	0 = Okay 1 = Open			✓	✓
Upper Temp Short (Upper temperature Probe shorted status)	Binary Input 302	Present_Value	R	0 = Okay 1 = Shorted			✓	✓
MXi Call For Heat	Binary Input 303	Present_Value	R	0 = No 1 = Yes				✓
Lower Temp Open (Upper temperature Probe open status)	Binary Input 304	Present_Value	R	0 = Okay 1 = Open			✓	✓
Lower Temp Short (Upper temperature Probe shorted status)	Binary Input 305	Present_Value	R	0 = Okay 1 = Shorted			✓	✓
Igntr Current OK (Igniter Current Sensed)	Binary Input 306	Present_Value	R	0=No Current 1=Current Sensed			✓	
Flame Sensed (Igniter Current Sensed)	Binary Input 307	Present_Value	R	0=No Flame 1=Flame Sensed			✓	✓
Blower Prove PS (Blower Prove pressure switch)	Binary Input 308	Present_Value	R	0=Open Switch 1=Closed Switch			✓	✓
Ext Vent PS (External Vent pressure switch status if selected by DIP switch on CCB)	Binary Input 309	Present_Value	R	0=Open Switch 1=Closed Switch			✓	
Blocked Exhaust PS (Blocked exhaust pressure switch)	Binary Input 310	Present_Value	R	0=Open Switch 1=Closed Switch			✓	✓
Blocked Inlet PS (Blocked air intake pressure switch)	Binary Input 311	Present_Value	R	0=Open Switch 1=Closed Switch			✓	✓
Low Gas PS (Low Gas supply pressure switch)	Binary Input 312	Present_Value		0=Open Switch 1=Closed Switch			✓	✓
Upper Temp ECO (Upper temperature probe high temperature Energy Cut Out Status)	Binary Input 313	Present_Value		0=Open Switch 1=Closed Switch			✓	✓
External T'stat (External Thermostat status if selected by DIP switch on CCB)	Binary Input 314	Present_Value		0 = No 1 = Yes			✓	
Xi 1.0 Call For Heat (Conditions are satisfied to allow heater to heat water)	Binary Input 315	Present_Value		0 = Okay 1 = Alarm				✓
MXi LowTemp Alrm (Tank temperature below Low Tank Temperature Alarm setpoint)	Binary Input 316	Present_Value		0 = Okay 1 = Alarm				✓
MXi LeakDetected (Optional Leak detector circuit detected water)	Binary Input 317	Present_Value		0=No Leak 1=Leak Detected				✓
Mxi HeaterEnab'd (Front Switch Heater Enable status)	Binary Input 318	Present_Value		0=Disabled 1 = Enabled				✓
MXi External Enab (Optional input status)	Binary Input 319	Present_Value		0=Disabled 1 = Enabled				✓
Xi 1.0 Ign Tries (Number of tries for ignition set by DIP switch on CCB)	Binary Input 320	Present_Value		0 = 3 tries 1 = 1 try			✓	
Ext Vent Relay (External Vent Relay output commanded status)	Binary Output 401	Present_Value		0 = Off 1 = On			✓	

1. Data is encoded into the 16 bits as major revision (upper 8 bits) and minor revision (lower 8 bits).

2. Not recommended for use currently as UIM does not currently support and warning will come up as "Unknown."

## BACnet / Gas Water Heaters

**Table 10. BACnet/Gas Water Heaters Object List**

BACnet Object Name (Description)	BACnet Object Type/Inst.	BACnet Object Property	R/W	Units	Min Value (if W)	Max Value (if W)	Xi 1.0	Mxi
Blower Relay (Blower Relay output commanded status)	Binary Output 402	Present_Value		0 = Off 1 = On			✓	✓
Ignition Relay (Ignition Relay output commanded status)	Binary Output 403	Present_Value		0 = Off 1 = On			✓	✓
Gas Valve Relay (Gas valve Relay output commanded status)	Binary Output 404	Present_Value		0 = Off 1 = On			✓	✓
MXi Ign Tries (Selects 1 or 3 tries for ignition. Settable at UIM)	Binary Value 501	Present_Value		0 = 3 tries 1 = 1 try				✓
MXi Use Ext Enab (Selects whether or not to use Optional External Enable Input. Settable at UIM)	Binary Value 502	Present_Value		0 = No 1 = Yes				✓
MXi Modulation (CCB S/W version 3.15 or higher. Disables modulation on heaters that have it. May be helpful if plumbed with Xi 1.0. Settable at UIM)	Binary Value 503	Present_Value		0=Disabled 1=Enabled				✓
System In Fault	Binary Value 504	Present_Value		0 = Okay 1 = Alarm			✓	✓
System State (CCB Control State)	Multistate Value 801	Present_Value		See Table 10			✓	✓
Fault Code	Multistate Value 802	Present_Value		See Table 13			✓	✓
Alert Code	Multistate Value 803	Present_Value		See Table 13			✓	✓

1. Data is encoded into the 16 bits as major revision (upper 8 bits) and minor revision (lower 8 bits).  
 2. Not recommended for use currently as UIM does not currently support and warning will come up as "Unknown."

### Central Control Board Major State Definitions

**Table 11. Gas Central Control Board (CCB) Major State Definitions**

Value	Xi 1.0 State	MXi State
1	Off (Standby)	Off (Standby)
2	Pre-Purge	Pre-Purge
3	Igniter Warmup	Igniting
4	Ignition Activation	Gas Valve On
5	Ignition Verification	Inter-Purge
6	Inter-Purge	Heating
7	Heating	Post-Purge
8	Post-Purge	In Fault
9	Fault	

### Xi 1.0 Energy Management System (EMS) Control

Xi 1.0 uses a single bit setting method. Within the EMS Mode-Status point one bit command (bit 15) sets it in EMS mode, and other ends EMS mode. Once in EMS mode, another bit command (bit 0) enables heating another disables heating.

Once in EMS mode the EMS Mode Refresh command must be periodically issued which clears a third bit (bit 14) to maintain EMS mode, otherwise the heater will end EMS mode and resume normal operation.

## BACnet / Gas Water Heaters

**Table 12. Xi 1.0 Energy Management System (EMS) Control**

Decimal	Hex	Value	Response
3840	0x0F00	No EMS control	0 / 0x000
3841	0x0F01	Put into EMS Mode <sup>^</sup>	49152 / 0xC000
0000	0x0000	EMS Disable heating <sup>^</sup>	49152 / 0xC000
0001	0x0001	EMS Enable heating <sup>^</sup>	49153 / 0xC001
3584	0x0E00	EMS Mode Refresh <sup>^</sup> (must write within 30 seconds or EMS mode ends.) 15 seconds or less recommended	49152 / 0xC000 or 49153 / 0xC001 depending on whether or not heating is enabled.

**Notes:**

The start of a heating also depend on other factors like tank temperature dropping below Setpoint – Differential and External T'stat call for heat if that option is enabled.

Depending on when you poll the register, you may read bit 14 as 1 which is why a "C" (in hexadecimal form) might briefly reply with "8". This is due to the control setting this bit and if it not cleared periodically by the BACnet command, heating is disabled.

After disabling EMS mode with write of 3840, read back might have bits 14 and 1 possibly still set. To make sure these bits are clear, write a 0000 to clear bit 1 and 3584 to clear bit 14.

### Mxi Energy Management System (EMS) Control

Mxi EMS control is written as a single command to place in EMS mode and enable or disable heating.

Once in EMS mode the EMS Mode Refresh command must be periodically issued to maintain EMS mode, otherwise the heater will end EMS mode and resume normal operation.

**Table 13. Mxi Energy Management System (EMS) Control**

Decimal	Hex	Value	Response
0	0x0000	No EMS control~	0 / 0x000
32768	0x8000	EMS Disable Heating <sup>^</sup>	49152 / 0xC000
32769	0x8001	EMS Enable Heating <sup>^*</sup>	49153 / 0xC001

**Notes:**

~ For Versions less than 3.16, once EMS control mode is enabled it remains enabled through BACnet it will remain in EMS control mode that cannot be cleared by writing a 0 to it. Power cycling only can clear EMS mode.

<sup>^</sup> Depending on when you poll the register, you may read bit 14 as 1 which is why a "C" (in hexadecimal form) might briefly reply with "8". This is due to the control setting this bit and if it not cleared periodically by the BACnet command, heating is disabled.

\* EMS command to heat must be sent every 30 maximum or heating will be disabled.



**Fault Codes and Warnings**

**Note:** Any Fault not listed is an internal CCB failure fault.

<b>Table 14. Fault Codes and Warnings</b>		
<b>Index Range (Decimal)</b>		<b>Value</b>
1	1	Okay (No Fault)
1	6	Memory
24		Incorrect Model
51	56	Power Monitor
69	72	Temperature Probe Open or Short
129	129	Leak Detected
153	154	Communications Fault
165		High temperature ECO (Energy Cut Off)
175		Safety Relay Closed fault
176	188	CCB internal errors
193	194	Processor Clock
198	201	Non-volatile Memory
204	217	Powered Anode
431		Safety Relay Opened fault

**BACNET / ELECTRIC WATER HEATERS**



Figure 36. Custom and Gold Xi™ Series Electric Water Heaters (Virtual BACnet device via ICC Gateway)

**PRODUCT DESCRIPTION**

The Mirius is a multiprotocol RS-485 to RS-485 gateway. The ETH-1000 is an Ethernet to RS-485 multiprotocol gateway. These products supports native BACnet, connecting directly to IP or the MS/TP LAN using baud rates of 4800, 9600, 19200, 38400, 57600, 76800, and 115200. As shipped the devices are configured as a BACnet Server.

All electronic controls provide communications via propriety protocol with the ICC Gateway. The Mirius supports BACnet MS/TP communications and the ETH-1000 supports BACnet IP to access data available at the display plus control of a limited number of points such as Operating Setpoint.

**PROTOCOL IMPLEMENTATION CONFORMANCE STATEMENT (PICS)**

**BACnet Standardized Device Profile (Annex L):**

BACnet Application Specific Controller (B-ASC)

**BACnet Interoperability**

Table 15. BACnet Interoperability Building Blocks Supported (Annex K):	
Data Sharing - ReadProperty-A (DS-RP-A)	☑
Data Sharing - ReadProperty-B (DS-RP-B)	☑
Data Sharing - ReadPropertyMultiple-B (DS-RPM-B)	☑
Data Sharing - WriteProperty-A (DS-WP-A)	☑
Data Sharing - WriteProperty-B (DS-WP-B)	☑
Data Sharing - WritePropertyMultiple-B (DS-WPM-B)	☑
Data Sharing – COV-B (DS-COV-B) (BACnet/IP only)	☑
Device Management-Dynamic Device Binding-A (DM-DDB-A)	☑
Device Management-Dynamic Device Binding-B (DM-DDB-B)	☑
Device Management-Dynamic Object Binding-B (DM-DOB-B)	☑

## BACnet / Electric Water Heaters

**Table 15. BACnet Interoperability Building Blocks Supported (Annex K):**

Device Management-Device Communication Control-B (DM-DCC-B)	<input checked="" type="checkbox"/>
Device Management – ReinitializeDevice-B (DM-RD-B)	<input checked="" type="checkbox"/>

### Segmentation Capability

Segmentation not supported.

### Data Link Layer Options

**Table 16. Data Link Layer Options**

BACnet IP (Annex J) (ETH-1000 only)	<input checked="" type="checkbox"/>
BACnet IP (Annex J), Foreign Device (ETH-1000 only)	<input checked="" type="checkbox"/>
ANSI/ATA 878.1, 2.5Mb. ARCNET (Clause 8)	<input type="checkbox"/>
ANSI/ATA 878.1, RS-485. ARCNET (Clause 8), baud rates() _____	<input type="checkbox"/>
MS/TP master (Clause9) baud rate(s): 4800, 19200, 38400, 57600, 76800, 115200	<input checked="" type="checkbox"/>
MS/TP slave (Clause9) baud rate(s): _____	<input type="checkbox"/>
Point-To-Point, EIA 232 (Clause 10), baud rate(s): _____	<input type="checkbox"/>
Point-To-Point, modem (Clause 10), baud rate(s): _____	<input type="checkbox"/>
LonTalk, (Clause 11), medium _____	<input type="checkbox"/>
Other: _____	<input type="checkbox"/>

### Device Address Binding

Is static device binding supported? (This is currently for two-way communications with MS/TP slaves and certain other devices.) YES

### Networking Options

**Table 17. Networking Options**

Router, Clause 6 – List all routing configurations	<input type="checkbox"/>
Annex H, BACnet Tunneling Router over IP	<input type="checkbox"/>
BACnet/IP Broadcast Management Device (BBMD). Does the BBMD support registrations by Foreign Devices? (ETH-1000 only)	<input checked="" type="checkbox"/>

### Character Sets

**Table 18. Character Sets Supported**

ANSI X3.4	<input checked="" type="checkbox"/>
IBMTM /MicrosoftTM DBCS	<input type="checkbox"/>
ISO 8859-1	<input type="checkbox"/>
ISO 10646 (UCS-2)	<input type="checkbox"/>
ISO 10646 (UCS-4)	<input type="checkbox"/>
JIS C 6226	<input type="checkbox"/>

Data Types

Table 19. Data Types Supported		
Object Type	Service	
	Read Property	Write Property
Analog Output Analog Value	Real	Real, Unsigned, Integer, Null
Analog Input	Real	N/A
Binary Output Binary Value	Enumerated	Enumerated, Boolean, Real, Unsigned, Integer, Null
Binary Input	Enumerated	N/A
Multi-state Output Multi-state Value	Unsigned	Real, Enumerated, Unsigned, Integer, Null
Multi-state Input	Unsigned	N/A

Object Types and Property Support

Table 20. Object Types/Property Support Table										
Property	Device	Binary Input	Binary Output	Binary Value	Analog Input	Analog Output	Analog Value	Multi Input	Multi Output	Multi Value
Object Identifier	R	R	R	R	R	R	R	R	R	R
Object Name	R	R	R	R	R	R	R	R	R	R
Object Type	R	R	R	R	R	R	R	R	R	R
System Status	R									
Vendor Name	R									
Vendor Identifier	R									
Model Name	R									
Firmware Revision	R									
App S/W Revision	R									
Protocol Revision	R									
Services Supported	R									
Object Types Supported	R									
Object List	R									
Max APDU Length	R									
Segmentation Support	R									
APDU Timeout	R									
Number APDU Retries	R									
Max master	R									
Max Info Frames	R									
Device Address Binding	R									
Database Revision	R									
Present Value		R	W	W	R	W	W	R	W	W
Status Flags		R	R	R	R	R	R	R	R	R
Event State		R	R	R	R	R	R	R	R	R
Out-of Service		R	R	R	R	R	R	R	R	
Units					R	R	R	R	R	R
Priority Array			R			R	R		R	R
Relinquish Default			R			R	R		R	R
Polarity		R	R							

R - readable using BACnet services  
W - readable and writable using BACnet services



## BACnet / Electric Water Heaters

**Table 20. Object Types/Property Support Table**

Property	Device	Binary Input	Binary Output	Binary Value	Analog Input	Analog Output	Analog Value	Multi Input	Multi Output	Multi Value
Inactive Text		R	R							
Active Text		R	R							

R - readable using BACnet services  
W - readable and writable using BACnet services

### DEVICE OBJECT LISTINGS

#### Device Objects Initial Values

**Table 21. BACnet/Electric Water Heaters Device Object**

Property Name	ID	BACnet Data Type	RW	Initial Value (Mirus)	Initial Value (ETH-1000)
Object_Identifier	75	Object Identifier	RW	Device, 520081	Device, 520081
Object_Name	77	Character String	RW	Elec Water Heater	Elec Water Heater
Object_Type	79	Enumerated	R	Device	Device
System_Status	112		R	Operational	Operational
Vendor_Name	121		R	ICC, Inc.	
Vendor_Identifier	120		R	242	
Model_Name	70		R	Mirus	ETH-1000
Firmware_Revision	44	Character String	R	V3.000	V4.001
Application_Software_Version	12		R	V3.000	V4.001
Protocol_Version	98		R	1	1
Protocol_Revision	139		R	12	12
Protocol_Services_Supported	97		R	See PICS	See PICS
Protocol_Object_Types_Supported	96		R	AI, AO, AV, BI, BO, BV, MSI, MSO, MSV	AI, AO, AV, BI, BO, BV, MSI, MSO, MSV
Object_List	76		R	See Table	See Table
Max_APDU_Length_Accepted	62		R	480	1444
Segmentation_Supported	107		R	3	3
APDU_Timeout	10		RW	1000ms	1000ms
Number_Of_APDU_Retries	73		R	3	3
Max_Master	64		RW	127	Unsupported
Device_Address_Binding	30		R	{}	{}
Local_Date	56		R	Unsupported	Unsupported
Local_Time	57		R	Unsupported	Unsupported

#### Device Objects Minimum/Maximum Values

- Not all models support all registers. Also parameter names may be different than shown here on some models.
- This table may be subject to change in the future.
- Adjustable objects are in bold and indicated by "W" (writable).
- Mirius Object names may be abbreviated to fit in 16 characters.
- Where noted, some objects implemented only in ETH-1000.

**Table 22. BACnet/Electric Water Heaters Object List**

BACnet Object Name (Description)	BACnet Object Type/Inst.	BACnet Object Property	R/W	Units	Min Value (if W)	Max Value (if W)
Firmware Ver-Rev <sup>1</sup> (Firmware Version)	Analog Input 1	Present_Value	R			
Configuration	Analog Input 2	Present_Value	R			

1. Data is encoded into the 16 bits as major revision (upper 8 bits) and minor revision (lower 8 bits).

**BACnet / Electric Water Heaters**

Table 22. BACnet/Electric Water Heaters Object List						
BACnet Object Name (Description)	BACnet Object Type/Inst.	BACnet Object Property	R/W	Units	Min Value (if W)	Max Value (if W)
Tank Temperature (Controlling (Tank) Temperature)	Analog Input 5	Present_Value	R	°C		
Lower Temperature (Lower or Secondary Temperature)	Analog Input 4	Present_Value	R	°C		
Tank Temperature (Controlling Tank Temperature algorithmically calculated)	Analog Input 5	Present_Value	R	°C		
<b>Temper Setpoint</b> (Desired Tank Temperature)	Analog Value 201	Present_Value	R/W	°C (°F)	32.2 (90)	82.2 (180)
<b>Differen'lBank1</b> (Differential Setpoint Bank 1)	Analog Value 202	Present_Value	R/W	°C (°F)	.6 (1)	11.1 (20)
<b>Differen'lBank2</b> (Differential Setpoint Bank 2)	Analog Value 203	Present_Value	R/W	°C (°F)	.6 (1)	11.1 (20)
<b>Differen'lBank3</b> (Differential Setpoint Bank 3)	Analog Value 204	Present_Value	R/W	°C (°F)	.6 (1)	11.1 (20)
<b>Differen'lBank4</b> (Differential Setpoint Bank 4)	Analog Value 205	Present_Value	R/W	°C (°F)	.6 (1)	11.1 (20)
<b>Differen'lBank5</b> (Differential Setpoint Bank 5)	Analog Value 206	Present_Value	R/W	°C (°F)	.6 (1)	11.1 (20)
Number of Cycles (Number of heating cycles)	Analog Value 209	Present_Value	R	Number		
Elapsed Time (Time heater has been powered up in Hours with two place beyond the decimal)	Analog Value 210	Present_Value	R	Hours with two places beyond the decimal.		
Elapsed Days (The number of days that the heater has been powered up)	Analog Value 211	Present_Value	R	Days		
Elapsed Hours (The hours portion that the heater has been powered up. Use with Elapsed Days)	Analog Value 212	Present_Value	R	Hours		
Heating Time (Time heater has been actually heating water in Hours with two place beyond the decimal)	Analog Value 213	Present_Value	R	Hours with two places beyond the decimal.		
Heating Days (The amount of time in number of days heater has been actually heating water)	Analog Value 214	Present_Value	R	Days		
Heating Hours (The hour's portion of the amount of time heater has been actually heating water. Use with Heating Days)	Analog Value 215	R	R	Hours		
#CCB HW Faults (CCB Hardware Fault Counter)	Analog Value 217	Present_Value	R	Number		
#Model Faults ETH-1000 ONLY (Model Fault Counter)	Analog Value 218	Present_Value	R	Number		
#Temp Probe Faults (Temperature Probe Fault Counter)	Analog Value 219	Present_Value	R	Number		
#CCB Comm Faults ETH-1000 only (Communication Fault Counter)	Analog Value 223	Present_Value	R	Number		
#ECO Faults (High temperature Energy Cut Off switch in Upper temperature probe Fault Counter)	Analog Value 224	Present_Value	R	Number		
#Powr Anode Flts (Powered Anode Alert Counter)	Analog Value 233	Present_Value	R	Number		
#Element Faults (Element Fault Counter)	Analog Value 234	Present_Value	R	Number		
#LWCO Faults (Low Water Cut Off Fault Counter)	Analog Value 235	Present_Value	R	Number		
#Element Banks Used (Number of Element Banks in Water Heater)	Analog Value 236	Present_Value	R	Number		

1. Data is encoded into the 16 bits as major revision (upper 8 bits) and minor revision (lower 8 bits).

**BACnet / Electric Water Heaters**

<b>Table 22. BACnet/Electric Water Heaters Object List</b>						
<b>BACnet Object Name (Description)</b>	<b>BACnet Object Type/Inst.</b>	<b>BACnet Object Property</b>	<b>R/W</b>	<b>Units</b>	<b>Min Value (if W)</b>	<b>Max Value (if W)</b>
#Elements in Bank 1 (Number elements current is check for in bank 1)	Analog Value 237	Present_Value	R	Number		
#Elements in Bank 2 (Number elements current is check for in bank 2)	Analog Value 238	Present_Value	R	Number		
#Elements in Bank 3 (Number elements current is check for in bank 3)	Analog Value 239	Present_Value	R	Number		
#Elements in Bank 4 (Number elements current is check for in bank 4)	Analog Value 240	Present_Value	R	Number		
#Elements in Bank 5 (Number elements current is check for in bank 5)	Analog Value 241	Present_Value	R	Number		
#Banks Cmd'd On (Number of Banks currently Commanded to be on)	Analog Value 242	Present_Value	R	Number		
Bank On Time ETH-1000 only (Time bank has been powered up in Hours with two place beyond the decimal)	Analog Value 243	Present_Value	R	Hours with two places beyond the decimal.		
Bank1 On Days (The amount of time in number of days bank has been actually heating water)	Analog Value 244	Present_Value	R	Days		
Bank1 On Hours (The hour's portion of the amount of time bank has been actually heating water. Use with Bank1 On Days)	Analog Value 245	Present_Value	R	Hours		
Bank2 On Time ETH-1000 only (Time bank has been powered up in Hours with two place beyond the decimal)	Analog Value 246	Present_Value	R	Hours with two places beyond the decimal.		
Bank2 On Days (The amount of time in number of days bank has been actually heating water)	Analog Value 247	Present_Value	R	Days		
Bank2 On Hours (The hour's portion of the amount of time bank has been actually heating water. Use with Bank2 On Days)	Analog Value 248	Present_Value	R	Hours		
Bank3 On Time ETH-1000 only (Time bank has been powered up in Hours with two place beyond the decimal)	Analog Value 249	Present_Value	R	Hours with two places beyond the decimal.		
Bank3 On Days (The amount of time in number of days bank has been actually heating water)	Analog Value 250	Present_Value	R	Days		
Bank3 On Hours (The hour's portion of the amount of time bank has been actually heating water. Use with Bank3 On Days)	Analog Value 251	Present_Value	R	Hours		
Bank4 On Time ETH-1000 only (Time bank has been powered up in Hours with two place beyond the decimal)	Analog Value 252	Present_Value	R	Hours with two places beyond the decimal.		
Bank4 On Days (The amount of time in number of days bank has been actually heating water)	Analog Value 253	Present_Value	R	Days		
Bank4 On Hours (The hour's portion of the amount of time bank has been actually heating water. Use with Bank4 On Days)	Analog Value 254	Present_Value	R	Hours		

1. Data is encoded into the 16 bits as major revision (upper 8 bits) and minor revision (lower 8 bits).

**BACnet / Electric Water Heaters**

**Table 22. BACnet/Electric Water Heaters Object List**

<b>BACnet Object Name (Description)</b>	<b>BACnet Object Type/Inst.</b>	<b>BACnet Object Property</b>	<b>R/W</b>	<b>Units</b>	<b>Min Value (if W)</b>	<b>Max Value (if W)</b>
Bank5 On Time ETH-1000 only (Time bank has been powered up in Hours with two place beyond the decimal)	Analog Value 255	Present_Value	R	Hours with two places beyond the decimal.		
Bank5 On Days (The amount of time in number of days bank has been actually heating water)	Analog Value 256	Present_Value	R	Days		
Bank5 On Hours (The hour's portion of the amount of time bank has been actually heating water. Use with Bank5 On Days)	Analog Value 257	Present_Value	R	Hours		
Bank 1 Heating Cycles	Analog Value 258	Present_Value	R	Number		
Bank 2 Heating Cycles	Analog Value 259	Present_Value	R	Number		
Bank 3 Heating Cycles	Analog Value 260	Present_Value	R	Number		
Bank 4 Heating Cycles	Analog Value 261	Present_Value	R	Number		
Bank 5 Heating Cycles	Analog Value 262	Present_Value	R	Number		
<b>EMS Mode-Status</b>	Analog Value 263	Present_Value	R/W	see table 3		
Element Status (Each bit is state a separate element)	Analog Value 264	Present_Value	R	Bit 0 = Element 1 Bit 1 = Element 2 . . . Bit 14 = Element 15		
Temp Probe Open (Temperature Probe open status)	Binary Input 301	Present_Value	R	0 = Okay 1 = Open		
Temp Probe Short (Temperature Probe shorted status)	Binary Input 302	Present_Value	R	0 = Okay 1 = Shorted		
Temp Probe ECO Status (Temperature probe high temperature Energy Cut Out Status)	Binary Input 313	Present_Value	R	0=Open Switch 1=Closed Switch		
Safety Relay Feedback	Binary Input 321	Present_Value	R	0=Open 1=Closed		
Tank Full (LWCO)	Binary Input 322	Present_Value	R	0=Open Switch 1=Closed Switch		
AC Input1 T'stat (External Enable 1)	Binary Input 323	Present_Value	R	0=Open 1=Closed		
AC Input2 T'stat (External Enable 2)	Binary Input 324	Present_Value	R	0=Open 1=Closed		
Bank1 Output Status	Binary Output 405	Present_Value	R	0=Off 1=On		
Bank2 Output Status	Binary Output 406	Present_Value	R	0=Off 1=On		
Bank3 Output Status	Binary Output 407	Present_Value	R	0=Off 1=On		
Bank4 Output Status	Binary Output 408	Present_Value	R	0=Off 1=On		
Bank5 Output Status	Binary Output 409	Present_Value	R	0=Off 1=On		
Alarm Condition	Binary Value504	Present_Value	R	0=False 1=True		
Output Relay Status	Binary Value 505	Present_Value	R	0=Relay Off 1=Relay On		
System In Fault	Binary Value 504	Present_Value	R	0 = Okay 1 = In Fault	0	1

1. Data is encoded into the 16 bits as major revision (upper 8 bits) and minor revision (lower 8 bits).

## BACnet / Electric Water Heaters

**Table 22. BACnet/Electric Water Heaters Object List**

BACnet Object Name (Description)	BACnet Object Type/Inst.	BACnet Object Property	R/W	Units	Min Value (if W)	Max Value (if W)
CCB System State (Central Control Board Control State)	Multistate Value 801	Present_Value	R	See <i>Table 23</i> .		
Fault Code	Multistate Value 802	Present_Value	R	See <i>Table 25</i> .		
Alert Code	Multistate Value 803	Present_Value	R	See <i>Table 25</i>		

1. Data is encoded into the 16 bits as major revision (upper 8 bits) and minor revision (lower 8 bits).

### Central Control Board Major State Definitions

**Table 23. BACnet/Electric Water Heaters Central Control Board (CCB) State**

Value	State
0	Off (Standby)
6	Heating
8	Fault

### Energy Management System (EMS) Control

Commercial Electric water heaters with Xi controls use a single bit setting method. Within the EMS Mode-Status point one bit command (bit 15) sets it in EMS mode, and other ends EMS mode. Once in EMS mode, another bit command (bit 0) enables heating another disables heating.

Once in EMS mode the EMS Mode Refresh command must be periodically issued which clears a third bit (bit 14) to maintain EMS mode, otherwise the heater will end EMS mode and resume normal operation.

**Table 24. BACnet/Electric Water Heaters Energy Management System (EMS) Control**

Decimal	Hex	Value	Response
3841	0x0F01	Put into EMS Mode <sup>^</sup>	49152 / 0xC000
0000	0x0000	EMS Disable heating <sup>^</sup>	49152 / 0xC000
0001	0x0001	EMS Enable heating <sup>^</sup>	49153 / 0xC001
3584	0x0E00	EMS Mode Refresh <sup>^</sup> (must write within 30 seconds or EMS mode ends.) 15 seconds or less recommended	49152 / 0xC000 or 49153 / 0xC001 depending on whether or not heating is enabled.

Notes:

The start of a heating also depend on other factors like tank temperature dropping below Setpoint – Differential and External T<sup>’</sup>stat call for heat if that option is enabled.

<sup>^</sup>Depending on when you poll the register, you may read bit 14 as 1 which is why a “C” (in hexadecimal form) might briefly reply with “8”. This is due to the control setting this bit and if it not cleared periodically by the BACnet command, heating is disabled.

After disabling EMS mode with write of 3840, read back might have bits 14 and 1 possibly still set. To make sure these bits are clear, write a 0000 to clear bit 1 and 3584 to clear bit 14.

### Fault Codes and Warnings

**Note:** Any Fault not listed is an internal CCB failure fault.

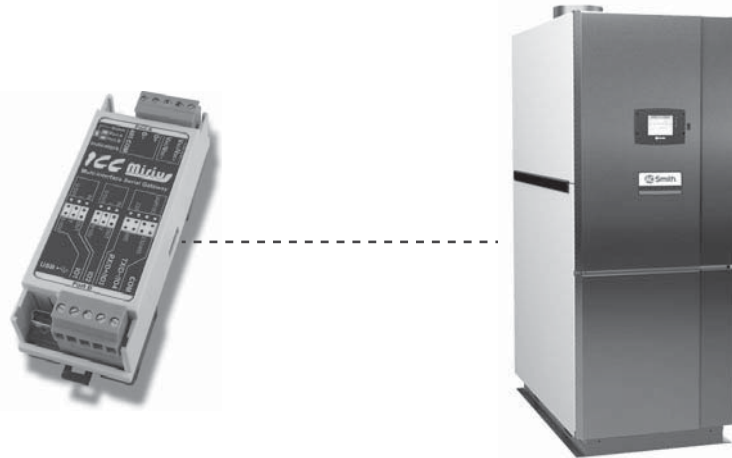
**Table 25. BACnet/Electric Water Heaters Fault codes and Warnings**

Index Range (Decimal)	Value
1	1
1	6
24	Incorrect Model

<b>Table 25. BACnet/Electric Water Heaters Fault codes and Warnings</b>		
<b>Index Range (Decimal)</b>		<b>Value</b>
51	56	Power Monitor
69	72	Temperature Probe Open or Short
153	154	Communications Fault
165		High temperature ECO (Energy Cut Off)
171		Low Water Cut-Off
175		Safety Relay Closed fault
176	188	CCB internal errors
193	194	Processor Clock
198	201	Non-volatile Memory
205	217	Powered Anode
431		Safety Relay Opened fault
1037	1037	Element Open Warning



**BACNET / BOILERS**



**Figure 37. XP XWH Circulating Water Heaters (Virtual Bacnet Device Via ICC Gateway)**

**PRODUCT DESCRIPTION**

The Mirius is a multiprotocol RS-485 to RS-485 gateway. The ETH-1000 is an Ethernet to RS-485 multiprotocol gateway. These products supports native BACnet, connecting directly to IP or the MS/TP LAN using baud rates of 4800, 9600, 19200, 38400, 57600, 76800, and 115200. As shipped the devices are configured as a BACnet Server.

All XI™ MXi™ controls provide communications via propriety protocol with the ICC Gateway. The Mirius supports BACnet MS/TP communications and the ETH- 1000 supports BACnet/IP to access data available at the display plus control of a limited number of points such as Operating Setpoint.

**PROTOCOL IMPLEMENTATION CONFORMANCE STATEMENT (PICS)**

**BACnet Standardized Device Profile (Annex L):**

BACnet Application Specific Controller (B-ASC)

**BACnet Boiler Interoperability**

<b>Table 26. BACnet Boiler Interoperability Building Blocks Supported (Annex K):</b>	
Data Sharing - ReadProperty-A (DS-RP-A)	☑
Data Sharing - ReadProperty-B (DS-RP-B)	☑
Data Sharing - ReadPropertyMultiple-B (DS-RPM-B)	☑
Data Sharing - WriteProperty-A (DS-WP-A)	☑
Data Sharing - WriteProperty-B (DS-WP-B)	☑
Data Sharing - WritePropertyMultiple-B (DS-WPM-B)	☑
Data Sharing – COV-B (DS-COV-B) (BACnet/IP only)	☑
Device Management-Dynamic Device Binding-A (DM-DDB-A)	☑
Device Management-Dynamic Device Binding-B (DM-DDB-B)	☑
Device Management-Dynamic Object Binding-B (DM-DOB-B)	☑
Device Management-Device Communication Control-B (DM-DCC-B)	☑
Device Management – ReinitializeDevice-B (DM-RD-B)	☑

**Segmentation Capability:**

Segmentation not supported

**Data Link Layer Options**

Table 27. BACnet Boiler Data Link Layer Options	
BACnet IP (Annex J) (ETH-1000 only)	<input checked="" type="checkbox"/>
BACnet IP (Annex J), Foreign Device (ETH-1000 only)	<input checked="" type="checkbox"/>
ANSI/ATA 878.1, 2.5Mb. ARCNET (Clause 8)	<input type="checkbox"/>
ANSI/ATA 878.1, RS-485. ARCNET (Clause 8), baud rates() _____	<input type="checkbox"/>
MS/TP master (Clause9) baud rate(s): 4800, 19200, 38400, 57600, 76800, 115200	<input checked="" type="checkbox"/>
MS/TP slave (Clause9) baud rate(s): _____	<input type="checkbox"/>
Point-To-Point, EIA 232 (Clause 10), baud rate(s): _____	<input type="checkbox"/>
Point-To-Point, modem (Clause 10), baud rate(s): _____	<input type="checkbox"/>
LonTalk, (Clause 11), medium _____	<input type="checkbox"/>
Other: _____	<input type="checkbox"/>

**Device Address Binding**

Is static device binding supported? (This is currently for two-way communications with MS/TP slaves and certain other devices.) YES

Table 28. BACnet Boiler Networking Options	
Router, Clause 6 – List all routing configurations	<input type="checkbox"/>
Annex H, BACnet Tunneling Router over IP	<input type="checkbox"/>
BACnet/IP Broadcast Management Device (BBMD). Does the BBMD support registrations by Foreign Devices? (ETH-1000 only)	<input checked="" type="checkbox"/>

**Character Sets**

Table 29. BACnet Boiler Character Sets Supported	
ANSI X3.4	<input checked="" type="checkbox"/>
IBM™ /Microsoft™ DBCS	<input type="checkbox"/>
ISO 8859-1	<input type="checkbox"/>
ISO 10646 (UCS-2)	<input type="checkbox"/>
ISO 10646 (UCS-4)	<input type="checkbox"/>
JIS C 6226	<input type="checkbox"/>

**Data Types Supported**

The following table summarizes the data types that are accepted (in the case of a write property service) and returned (in the case of a read property service) when targeting the present value property of each supported object type.

Table 30. BACnet Boiler Data Types Supported		
Object Type	Service	
	Read Property	Write Property
Analog Output Analog Value	Real	Real, Unsigned, Integer, Null
Analog Input	Real	N/A
Binary Output Binary Value	Enumerated	Enumerated, Boolean, Real, Unsigned, Integer, Null
Binary Input	Enumerated	N/A
Multi-state Output Multi-state Value	Unsigned	Real, Enumerated, Unsigned, Integer, Null
Multi-state Input	Unsigned	N/A

Boiler Device Object Types/Property Support

Table 31. BACnet Boiler Object Types/Property Support Table										
Property	Device	Binary Input	Binary Output	Binary Value	Analog Input	Analog Output	Analog Value	Multi Input	Multi Output	Multi Value
Object Identifier	R	R	R	R	R	R	R	R	R	R
Object Name	R	R	R	R	R	R	R	R	R	R
Object Type	R	R	R	R	R	R	R	R	R	R
System Status	R									
Vendor Name	R									
Vendor Identifier	R									
Model Name	R									
Firmware Revision	R									
App S/W Revision	R									
Protocol Revision	R									
Services Supported	R									
Object Types Supported	R									
Object List	R									
Max APDU Length	R									
Segmentation Support	R									
APDU Timeout	R									
Number APDU Retries	R									
Max master	R									
Max Info Frames	R									
Device Address Binding	R									
Database Revision	R									
Present Value		R	W	W	R	W	W	R	W	W
Status Flags		R	R	R	R	R	R	R	R	R
Event State		R	R	R	R	R	R	R	R	R
Out-of Service		R	R	R	R	R	R	R	R	R
Units					R	R	R	R	R	R
Priority Array			R			R	R		R	R
Relinquish Default			R			R	R		R	R
Polarity	R	R								
Inactive Text	R	R								
Active Text	R	R								

R - readable using BACnet services  
W - readable and writable using BACnet services

**OBJECT LISTINGS**

**Boiler Device Object Initial Values**

**Note:** Point listings have been changed completely from earlier versions of this listing.

Table 32. BACnet/Boiler Device Object					
Property Name	ID	BACnet Data Type	RW	Initial Value (Mirus)	Initial Value (ETH-1000)
Object_Identifier	75	Object Identifier	RW	Device, 520081	Device, 520081
Object_Name	77	Character String	RW	Water Heater-01	Water Heater-01
Object_Type	79	Enumerated	R	Device	Device

**Table 32. BACnet/Boiler Device Object**

Property Name	ID	BACnet Data Type	RW	Initial Value (Mirius)	Initial Value (ETH-1000)
System_Status	112		R	Operational	Operational
Vendor_Name	121		R	ICC, Inc.	ICC, Inc.
Vendor_Identifier	120		R	242	242
Model_Name	70		R	Mirius	ETH-1000
Firmware_Revision	44	Character String	R	V3.300	V4.002
Application_Software_Version	12		R	V3.300	V4.002
Protocol_Version	98		R	1	
Protocol_Revision	139		R	2	
Protocol_Services_Supported	97		R	See PICS	
Protocol_Object_Types_Supported	96		R	AI, AO, AV, BI, BO, BV, MSI, MSO, MSV	AI, AO, AV, BI, BO, BV, MSI, MSO, MSV
Object_List	76		R	See Table	See Table
Max_APDU_Length_Accepted	62		R	480	1444
Segmentation_Supported	107		R	3	3
APDU_Timeout	10		RW	1000ms	1000ms
Number_Of_APDU_Retries	73		R	3	3
Max_Master	64		RW	127	Unsupported
Device_Address_Binding	30		R	{}	{}
Local_Date	56		R	Unsupported	Unsupported
Local_Time	57		R	Unsupported	Unsupported

**Boiler Device Object Min/Max Values**

- Not all models support all registers. Also parameter names may be different than shown here on some models.
- This table may be subject to change in the future.
- Adjustable objects are in **bold** and indicated by "W" (writable).

**Table 33. BACnet/Boiler Object List**

BACnet Object Name (Description)	BACnet Object Type/Inst.	BACnet Object Property	R/W	Units	Min Value (if W)	Max Value (if W)
Outlet Sensor	Analog Input 1	Present_Value	R	°C		
Inlet Sensor	Analog Input 2	Present_Value	R	°C		
Tank Sensor	Analog Input 3	Present_Value	R	°C		
Burner 1 Rate %	Analog Input 4	Present_Value	R	%		
Burner 2 Rate %	Analog Input 5	Present_Value	R	%		
Burner 3 Rate %	Analog Input 6	Present_Value	R	%		
Burner 4 Rate %	Analog Input 7	Present_Value	R	%		
Master FireRate%	Analog Input 8	Present_Value	R	%		
Slave 1 State	Analog Input 9	Present_Value	R	Number (See <i>Figure 33</i> )		
Slave 2 State	Analog Input 10	Present_Value	R	Number (See <i>Figure 33</i> )		
Slave 3 State	Analog Input 11	Present_Value	R	Number (See <i>Figure 33</i> )		
Slave 4 State	Analog Input 12	Present_Value	R	Number (See <i>Figure 33</i> )		
Access Status (Register Access Status)	Analog Input 13	Present_Value	R	Number (See <i>Table 35</i> )		
Lockout Code (Lockout i.e., fault and hold code)	Analog Input 14	Present_Value	R	Number (See <i>Table 37</i> )		

## BACnet / Boilers

**Table 33. BACnet/Boiler Object List**

BACnet Object Name (Description)	BACnet Object Type/Inst.	BACnet Object Property	R/W	Units	Min Value (if W)	Max Value (if W)
Pump Run Time	Analog Input 101	Present_Value	R/W	Seconds	0	64800 (18 hours)
DHW P Gain (Lead Lag P-gain)	Analog Input 102	Present_Value	R	Number	0	100
DHW I Gain (Lead Lag I-gain)	Analog Input 103	Present_Value	R	Number	0	100
DHW D Gain Lead Lag D-gain	Analog Input 104	Present_Value	R	Number	0	100
Mode Sensor Sel (Modulating Sensor Select / DHW demand switch)	Analog Input 201	Present_Value	R/W	Number See (Table 35).	0	11
Lead Lag Set Pt (Lead Lag DHW setpoint)	Analog Input 202	Present_Value	R/W	°C	-40°C	130°C
On Hysteresis (Lead Lag on hysteresis)	Analog Input 203	Present_Value	R/W	0=Disabled 1=Enabled	0°C	130°C
Off Hysteresis (Lead Lag on hysteresis)	Analog Input 204	Present_Value	R/W	0=Disabled 1=Enabled	0°C	130°C
DHW Hi Limit Set (Outlet high limit setpoint)	Analog Input 205	Present_Value	R	°C	-40°C	130°C
Frost Protect	Binary Output 401	Present_Value	R/W	0=Disabled 1=Enabled	0	1
Enable/Disable (Lead Lag Operation switch)	Binary Output 402	Present_Value	R/W	0=Disabled 1=Enabled	0	1

### Boiler Slave States

**Table 34. BACnet/Boiler Slave State Definitions**

Value	State
0	Unknown
1	Available
2	Add stage
3	Suspend stage
4	Firing
5	On leave
6	Disabled
7	Recovering

### Boiler Modbus Register Access

**Table 35. BACnet/Boiler Modbus Register Access Status**

Value	State
0	No register writes allowed
1	Installer register writes allowed
2	OEM register writes allowed
3	All register writes allowed

**Boiler Modulating Sensor Select/DHW Demand Switch**

<b>Table 36. BACnet/Boiler Modulating Sensor Select/DHW Demand Switch</b>	
Value	Response
0	DHW sensor
1	Outlet sensor
2	Inlet sensor
3	Modbus
4	Auto: DHW or Inlet
5	Auto: DHW or Outlet

**Lock and Hold Codes**

<b>Table 37. Lock and Hold Codes</b>		
Code	Description	Recommended Troubleshooting of Lockout Codes
<b>Safety Data Faults</b>		
1	Unconfigured safety data	1. New Device, complete device configuration and safety verification. 2. If fault repeats, replace module.
2	Waiting for safety data verification	3. Device in Configuration mode and safety parameters need verification and a device needs reset to complete verification. 4. Configuration ended without verification, re enter configuration, verify safety parameters and reset device to complete verification. 5. If fault repeats, replace module.
<b>Internal Operation Errors</b>		
3	Internal fault: Hardware fault	Internal Fault. 6. Reset Module. 7. If fault repeats, replace module.
4	Internal fault: Safety Relay key feedback error	
5	Internal fault: Unstable power (DCDC) output	
6	Internal fault: Invalid processor clock	
7	Internal fault: Safety relay drive error	
8	Internal fault: Zero crossing not detected	
9	Internal fault: Flame bias out of range	
10	Internal fault: Invalid Burner control state	
11	Internal fault: Invalid Burner control state flag	
12	Internal fault: Safety relay drive cap short	
13	Internal fault: PII shorted to ILK	
14	Internal fault: HFS shorted to LCI	
15	Internal fault: Safety relay test failed due to feedback ON	
16	Internal fault: Safety relay test failed due to safety relay OFF	
17	Internal fault: Safety relay test failed due to safety relay not OFF	
18	Internal fault: Safety relay test failed due to feedback not ON	
19	Internal fault: Safety RAM write	



**Table 37. Lock and Hold Codes**

Code	Description	Recommended Troubleshooting of Lockout Codes	
20	Internal fault: Flame ripple and overflow	Internal Fault. 1. Reset Module. 2. If fault repeats, replace module.	
21	Internal fault: Flame number of sample mismatch		
22	Internal fault: Bias changed since heating cycle starts		
23	Internal fault: Bias changed since heating cycle starts		
24	Internal fault: Spark voltage stuck low or high		
25	Internal fault: Spark voltage changed too much during flame sensing time		
26	Internal fault: Static flame ripple		
27	Internal fault: Flame rod shorted to ground detected		
28	Internal fault: A/D linearity test fails		
29	Internal fault: Flame bias cannot be set in range		
30	Internal fault: Flame bias shorted to adjacent pin		
31	Internal fault: SLO electronics unknown error		
32-46	Internal fault: Safety Key 0 through 14		
<b>System Errors</b>			
47	Flame Rod to ground leakage		1. Check the Module and display connections. 2. Check the Module power supply and make sure that both frequency, voltage and VA meet the specifications.
48	Static flame (not flickering)		
49	24VAC voltage low/high		
50	Modulation fault		
51	Pump fault		
52	Motor tachometer fault		
53	AC inputs phase reversed		
54	Safety GVT model ID doesn't match application's model ID		
55	Application configuration data block CRC errors		
56-57	RESERVED		
58	Internal fault: HFS shorted to IAS		
59	Internal Fault: Mux pin shorted		
<b>Normal Event Status</b>			
60	Internal Fault: HFS shorted to LFS	Internal sub-system fault. 1. Review alert messages for possible trends. 2. Correct possible problems. 3. If fault persists, replace module.	
61	Anti short cycle		
62	Fan speed not proved		
63	LCI OFF		
64	PII OFF		
65	Interrupted Airflow Switch OFF		
66	Interrupted Airflow Switch ON		
67	ILK OFF		
68	ILK ON		
69	Pilot test hold		
Will not be a lockout fault. Hold Only.			
1. Check wiring and correct any faults. 2. Check Interlocks connected to the LCI to assure proper function. 3. Reset and sequence the module; monitor the LCI status. 4. If code persists, replace the module.			
1. Check wiring and correct any faults. 2. Check Preignition Interlock switches to assure proper functioning. 3. Check the valve operation. 4. Reset and sequence the module; monitor the PII status. 5. If code persists, replace the module.			
1. Check wiring and correct any possible shorts. 2. Check airflow switches to assure proper functioning. 3. Check the fan/blower operation. 4. Reset and sequence the module; monitor the airflow status. 5. If code persists, replace the module.			
1. Check wiring and correct any possible shorts. 2. Check Interlock (ILK) switches to assure proper function. 3. Verify voltage through the interlock string to the interlock input with a voltmeter. 4. If steps 1-3 are correct and the fault persists, replace the module.			
1. Verify Run/Test is changed to Run. 2. Reset Module. 3. If fault repeats, replace module.			

Table 37. Lock and Hold Codes

Code	Description	Recommended Troubleshooting of Lockout Codes
70	Wait for leakage test completion	4. Internal Fault. Reset Module. 5. If fault repeats, replace module.
71-77	RESERVED	
78	Demand Lost in Run	1. Check wiring and correct any possible errors. 2. If previous steps are correct and fault persists, replace the module.
79	Outlet high limit	1. Check wiring and correct any possible errors. 2. Replace the Outlet high limit. 3. If previous steps are correct and fault persists, replace the module.
80	DHW high limit	1. Check wiring and correct any possible errors. 2. Replace the DHW high limit. 3. If previous steps are correct and fault persists, replace the module.
81	Delta T limit	1. Check Inlet and Outlet sensors and pump circuits for proper operation. 2. Recheck the Delta T Limit to confirm proper setting. 3. If previous steps are correct and fault persists, replace the module.
82	Stack limit	1. Check wiring and correct any possible errors. 2. Replace the Stack high limit. 3. If previous steps are correct and fault persists, replace the module.
83	Delta T exchanger/outlet limit	
84	Delta T inlet/exchanger limit	
85	Inlet/outlet inversion limit	
86	Inlet/outlet inversion limit	
87	Inlet/exchanger inversion limit	
88	Outlet T-rise limit	
89	Exchanger T-rise limit	
90	Heat exchanger high limit	
<b>Sensor Faults</b>		
91	Inlet sensor fault	1. Check wiring and correct any possible errors. 2. Replace the Inlet sensor. 3. If previous steps are correct and fault persists, replace the module.
92	Outlet sensor fault	1. Check wiring and correct any possible errors. 2. Replace the Outlet sensor. 3. If previous steps are correct and fault persists, replace the module.
93	DHW sensor fault	1. Check wiring and correct any possible errors. 2. Replace the DHW sensor. 3. If previous steps are correct and fault persists, replace the module.
94	Header sensor fault	1. Check wiring and correct any possible errors. 2. Replace the Header sensor. 3. If previous steps are correct and fault persists, replace the module.
95	Stack sensor fault	1. Check wiring and correct any possible errors. 2. Replace the Stack sensor. 3. If previous steps are correct and fault persists, replace the module.
96	Outdoor sensor fault	1. Check wiring and correct any possible errors. 2. Replace the Outdoor sensor. 3. If previous steps are correct and fault persists, replace the module.
97	Internal Fault: A2D mismatch.	Internal Fault.
98	Internal Fault: Exceeded VSNSR voltage	1. Reset Module.
99	Internal Fault: Exceeded 28V voltage tolerance	2. If fault repeats, replace module.
100	Pressure Sensor Fault	1. Verify the Pressure Sensor is a 4-20ma source. 2. Check wiring and correct any possible errors. 3. Test Pressure Sensor for correct operation. 4. Replace the Pressure sensor. 5. If previous steps are correct and fault persists, replace the module.
101-104	RESERVED	
<b>Flame Operation Faults</b>		
105	Flame detected out of sequence	1. Check that flame is not present in the combustion chamber. Correct any errors. 2. Make sure that the flame detector is wired to the correct terminal. 3. Make sure the F & G wires are protected from stray noise pickup. 4. Reset and sequence the module, if code reappears, replace the flame detector. 5. Reset and sequence the module, if code reappears, replace the module.

**BACnet / Boilers**

**Table 37. Lock and Hold Codes**

Code	Description	Recommended Troubleshooting of Lockout Codes
106	Flame lost in MFEP	1. Check pilot valve (Main Valve for DSI) wiring and operation - correct any errors. 2. Check the fuel supply. 3. Check fuel pressure and repeat turndown tests. 4. Check ignition transformer electrode, flame detector, flame detector siting or flame rod position. 5. If steps 1 through 4 are correct and the fault persists, replace the module.
107	Flame lost early in run	
108	Flame lost in run	
109	Ignition failed	
110	Ignition failure occurred	
111	Flame current lower than WEAK threshold	Internal hardware test. Not a lockout.
112	Pilot test flame timeout	Interrupted Pilot or DSI application and flame lost when system in "test" mode. 1. Reset the module to restart.
113	Flame circuit timeout	Flame sensed during Initiate or off cycle, hold 240 seconds, if present after 240 seconds, lockout.
114-121	RESERVED	
<b>Rate Proving Faults</b>		
122	Lightoff rate proving failed	1. Check wiring and correct any potential wiring errors. 2. Check High Fire Switch to assure proper function (not welded or jumpered). 3. Manually drive the motor to the High Fire position and adjust the HF switch while in this position and verify voltage through the switch to the HFS input with a voltmeter. 4. If steps 1-3 are correct and the fault persists, replace the module.
123	Purge rate proving failed	
124	High fire switch OFF	
125	High fire switch stuck ON	
126	Low fire switch OFF	1. Check wiring and correct any potential wiring errors. 2. Check Low Fire Switch to assure proper function (not welded or jumpered). 3. Manually drive the motor to the High Fire position and adjust the LF switch while in this position and verify voltage through the switch to the LFS input with a voltmeter. 4. If steps 1-3 are correct and the fault persists, replace the module.
127	Low fire switch stuck ON	
128	Fan speed failed during prepurge	
129	Fan speed failed during preignition	
130	Fan speed failed during ignition	1. Check wiring and correct any potential wiring errors. 2. Check VFDs ability to change speeds. 3. Change the VFD 4. If the fault persists, replace the module.
131	Fan movement detected during standby	
132	Fan speed failed during run	
133-135	RESERVED	
<b>Start-Check Faults</b>		
136	Interrupted Airflow Switch failed to close	1. Check wiring and correct any possible wiring errors. 2. Check Interrupted Airflow switch(es) to assure proper function. 3. Verify voltage through the airflow switch to the IAS input with a voltmeter. 4. If steps 1-3 are correct and the fault persists, replace the module.
137	ILK failed to close	1. Check wiring and correct any possible shorts. 2. Check Interlock (ILK) switches to assure proper function. 3. Verify voltage through the interlock string to the interlock input with a voltmeter. 4. If steps 1-3 are correct and the fault persists, replace the module.
138-142	RESERVED	
143	Internal fault: Flame bias out of range 1	
144	Internal fault: Flame bias out of range 2	
145	Internal fault: Flame bias out of range 3	
146	Internal fault: Flame bias out of range 4	
147	Internal fault: Flame bias out of range 5	
148	Internal fault: Flame bias out of range 6	
<b>Fault Codes 149 Through 165 are OEM-Specific Fault Codes.</b>		
149	Flame detected	OEM Specific 1. Holds if flame detected during Safe Start check up to Flame Establishing period.
150	Flame not detected	OEM Specific 1. Sequence returns to standby and restarts sequence at the beginning of Purge after the HF switch opens. If flame detected during Safe Start check up to Flame Establishing period.

Table 37. Lock and Hold Codes

Table 37. Lock and Hold Codes		
Code	Description	Recommended Troubleshooting of Lockout Codes
151	High fire switch ON	OEM Specific 1. Check wiring and correct any potential wiring errors. 2. Check High Fire Switch to assure proper function (not welded or jumpered). 3. Manually drive the motor to the High Fire position and adjust the HF switch while in this position and verify voltage through the switch to the HFS input with a voltmeter. 4. If steps 1-3 are correct and the fault persists, replace the module.
152	Combustion pressure ON	OEM Specific 1. Check wiring and correct any errors.
153	Combustion Pressure Off	2. Inspect the Combustion Pressure Switch to make sure it is working correctly. 3. Reset and sequence the relay module. 4. During STANDBY and PREPURGE, measure the voltage between Terminal J6-5 and L2 (N). Supply voltage should be present. If not, the lockout switch is defective and needs replacing. 5. If the fault persists, replace the relay module.
154	Purge Fan switch On	OEM Specific
155	Purge Fan switch Off	1. Purge fan switch is on when it should be off.
156	Combustion pressure and Flame ON	OEM Specific
157	Combustion pressure and Flame OFF	1. Check that flame is not present in the combustion chamber. Correct any errors. 2. Make sure that the flame detector is wired to the correct terminal. 3. Make sure the F & G wires are protected from stray noise pickup. 4. Reset and sequence the module, if code reappears, replace the flame detector.
158	Main valve ON	OEM Specific
159	Main valve OFF	1. Check Main Valve terminal wiring and correct any errors. 2. Reset and sequence the module. If fault persist, replace the module.
160	Ignition ON	OEM Specific
161	Ignition OFF	1. Check Ignition terminal wiring and correct any errors. 2. Reset and sequence the module. If fault persist, replace the module.
162	Pilot valve ON	OEM Specific
163	Pilot valve OFF	1. Check Pilot Valve terminal wiring and correct any errors. 2. Reset and sequence the module. If fault persist, replace the module.
164	Block intake ON	OEM Specific
165	Block intake OFF	1. Check wiring and correct any errors. 2. Inspect the Block Intake Switch to make sure it is working correctly. 3. Reset and sequence the module. 4. During Standby and Purge, measure the voltage across the switch. Supply voltage should be present. If not, the Block Intake Switch is defective and needs replacing. 5. If the fault persists, replace the relay module.
166-171	RESERVED	
<b>Feedback Codes</b>		
172	Main relay feedback incorrect	Internal Fault. 1. Reset Module. 2. If fault repeats, replace module.
173	Pilot relay feedback incorrect	
174	Safety relay feedback incorrect	
175	Safety relay open	
176	Main relay ON at safe start check	
177	Pilot relay ON at safe start check	
178	Safety relay ON at safe start check	
179-183	RESERVED	
<b>Parameter Faults</b>		
184	Invalid BLOWER/HSI output setting	3. Return to Configuration mode and recheck selected parameters, reverify and reset module. 4. If fault repeats, verify electrical grounding. 5. If fault repeats, replace module.
185	Invalid Delta T limit enable setting	
186	Invalid Delta T limit response setting	
187	Invalid DHW high limit enable setting	
188	Invalid DHW high limit response setting	
189	Invalid Flame sensor type setting	
190	Invalid interrupted air switch enable setting	
191	Invalid interrupted air switch start check enable setting	
192	Invalid igniter on during setting	
193	Invalid ignite failure delay setting	

**BACnet / Boilers**

**Table 37. Lock and Hold Codes**

<b>Code</b>	<b>Description</b>	<b>Recommended Troubleshooting of Lockout Codes</b>
194	Invalid ignite failure response setting	1. Return to Configuration mode and recheck selected parameters, reverify and reset module. 2. If fault repeats, verify electrical grounding. 3. If fault repeats, replace module.
195	Invalid ignite failure retries setting	
196	Invalid ignition source setting	
197	Invalid interlock open response setting	
198	Invalid interlock start check setting	
199	Invalid LCI enable setting	
200	Invalid lightoff rate setting	
201	Invalid lightoff rate proving setting	
202	Invalid Main Flame Establishing Period time	
203	Invalid MFEP flame failure response setting	
204	Invalid NTC sensor type setting	
205	Invalid Outlet high limit response setting	
206	Invalid Pilot Flame Establishing Period setting	
207	Invalid PII enable setting	
208	Invalid pilot test hold setting	
209	Invalid Pilot type setting	
210	Invalid Postpurge time setting	
211	Invalid Power up with lockout setting	
212	Invalid Preignition time setting	
213	Invalid Prepurge rate setting	
214	Invalid Prepurge time setting	
215	Invalid Purge rate proving setting	
216	Invalid Run flame failure response setting	
217	Invalid Run stabilization time setting	
218	Invalid Stack limit enable setting	
219	Invalid Stack limit response setting	
220	Unconfigured Delta T limit setpoint setting	1. Return to Configuration mode and recheck selected parameters, reverify and reset module. 2. If fault repeats, verify electrical grounding. 3. If fault repeats, replace module.
221	Unconfigured DHW high limit setpoint setting	
222	Unconfigured Outlet high limit setpoint setting	
223	Unconfigured Stack limit setpoint setting	
224	Invalid DHW demand source setting	
225	Invalid Flame threshold setting	
226	Invalid Outlet high limit setpoint setting	
227	Invalid DHW high limit setpoint setting	
228	Invalid Stack limit setpoint setting	
229	Invalid Modulation output setting	
230	Invalid CH demand source setting	
231	Invalid Delta T limit delay setting	
232	Invalid Pressure sensor type setting	
233	Invalid IAS closed response setting	
234	Invalid Outlet high limit enable setting	
235	Invalid Outlet connector type setting	
236	Invalid Inlet connector type setting	
237	Invalid DHW connector type setting	
238	Invalid Stack connector type setting	
239	Invalid S2 (J8-6) connector type setting	

<b>Table 37. Lock and Hold Codes</b>		
<b>Code</b>	<b>Description</b>	<b>Recommended Troubleshooting of Lockout Codes</b>
240	Invalid S5 (J8-11) connector type setting	
241	Exchanger sensor not allowed with stack connector setting	
242	Invalid DHW auto detect configuration	
243	Invalid UV with spark interference not compatible with Ignitor on throughout PFEP	
244	Internal fault: Safety relay test invalid state	
245	Invalid Outlet connector type setting for Trise	
246	4-20mA cannot be used for both modulation and setpoint control	
247	Invalid ILK bounce detection enable	
248	Invalid forced recycle interval	
249	STAT cannot be demand source when Remote Stat is enabled	
250	Invalid Fan speed error response	
251-255	RESERVED	

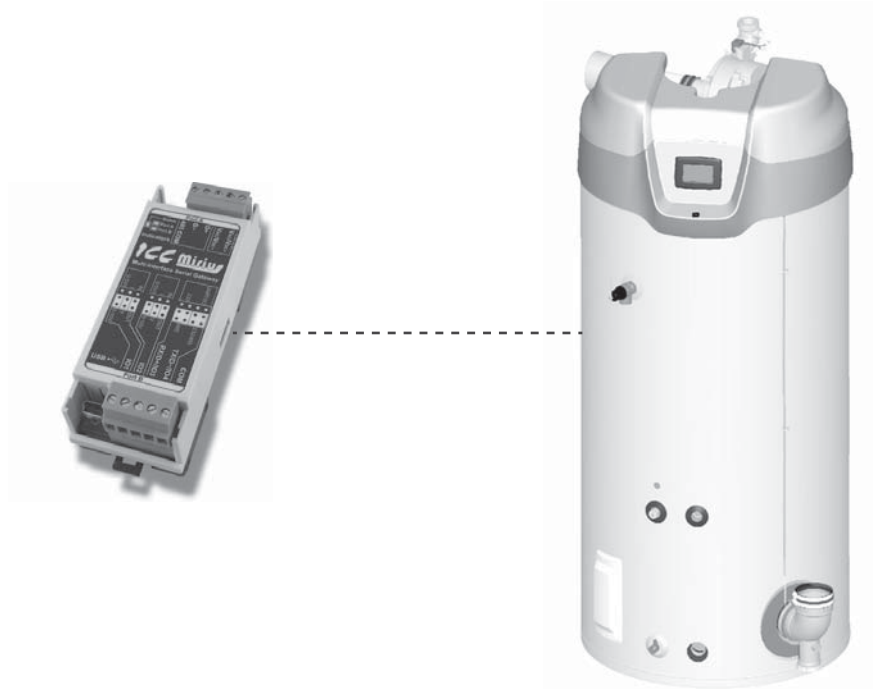


Figure 38. Cyclone® Xi Commercial Water Heaters (Virtual Modbus device via ICC Gateway)

**PRODUCT DESCRIPTION**

Cyclone® Xi water heaters are designed for commercial hot water applications. The Xi controls provide easy to read, plain English configuration and diagnostics. All Xi controls provide communications via propriety protocol with the ICC Gateway. The XLTR-1000 supports Modbus RTU communications and the ETH-1000 supports Modbus/TCP to access data available at the display plus control of limited number of points such as Operating Setpoint.

**MODBUS GAS WATER HEATER REGISTER LISTINGS**

**Modbus Gas Water Heater Register Properties**

- Not all models support all registers. Xi 1.0 or MXi noted where exclusively used on those models.
- This table may be subject to change in the future.
- Adjustable objects are in bold and indicated by “W” (writable).

Table 38. ModBus Gas Water Heaters Register List					
Register Name (Description)	Register Type Address	R/W	Units	Min Value (if W)	Max Value (if W)
Firmware Ver-Rev <sup>1</sup> (Firmware Version)	Input Register 1	R			
Configuration	Input Register 2	R			
Primary (Upper) Temperature	Input Register 3	R	°C x 512		
1. Data is Version encoded into the upper 8 bits and Revision (Lower 8 bits). 2. This limits modulation to maximum EMS Percent Commanded. 100% = Allow up to rated firing (faster recovery). 0% = minimum modulation rate more efficient but has a slower recovery rate i.e. derates heater capacity). 3. MXi only: Due to hardware design MXi cannot detect switch state when in fault condition and will read 0. In standby any switch of lower in the limit string than an open switch above it will also appear open. Limit string order is Low Gas Pressure, Blocked Exhaust, Blocked intake and Blower prove. 4. Data stored in two 16 bit registers “Big Endian” (Higher order bits in lower register number) 5. Hours and Days used together derived from Time (hours x 100). i.e. Elapsed Time of 13612.24 hours in “Days” and “Hours” = 567 days, 4 hours.					



**Table 38. ModBus Gas Water Heaters Register List**

<b>Register Name (Description)</b>	<b>Register Type Address</b>	<b>R/W</b>	<b>Units</b>	<b>Min Value (if W)</b>	<b>Max Value (if W)</b>
Lower Temperature (Lower or Secondary Temperature)	Input Register 4	R	°C x 512		
Tank Temperature (Controlling Tank Temperature algorithmically calculated)	Input Register 6	R	°C x 512		
<b>Setpoint Temperature</b>	Holding Register 7	R/W	°C x 512 (°F)	32.2 (90)	82.2 (180)
<b>SetPoint Differential</b>	Holding Register 8	R/W	°C x 512 (°F)	1.1 (2)	11.1 (20)
CCB Control State	Input Register 1040	R/W	See <i>Table 39</i>		
<b>EMS Status</b>	Holding Register 90	R/W	See <i>Table 40</i> (Xi 1.0) or <i>Table 41</i> (MXi)	32.2 (90)	82.2 (180)
<b>EMS Percent Commanded<sup>2</sup></b>	Holding Register 91	R/W	%	0%	100%
Fault Code	Input Register 1041	R	See <i>Table 42.</i>		
Alert Code	Input Register 1042	R	See <i>Table 42.</i>		
Xi 1.0 Call For Heat	Input Status 182	R	0=False 1=True		
MXi Call For Heat	Input Status 70	R	0=False 1=True		
Upper Temperature Probe Open	Input Status 65	R	0=False 1=True		
Upper Temperature Probe Short	Input Status 66	R	0=False 1=True		
Temperature Probe ECO status	Input Status 156	R	0=Open 1=Closed		
Lower Temperature Probe Open	Input Status 73	R	0=False 1=True		
Lower Temperature Probe Short	Input Status 74	R	0=False 1=True		
Igniter Current detected (Xi 1.0 only)	Input Status 148	R	0=No Current 1= OK		
Flame Current	Input Status 149	R	0=No Flame 1=Flame Detected		
Blower Prove Pressure Switch <sup>3</sup>	Input Status 151	R	0=Open Switch 1=Closed Switch		
External Vent Pressure Switch External T'stat Switch (Xi 1.0 only, function DIP selectable )	Input Status 152	R	0=Open Switch 1=Closed Switch		
Blocked Exhaust Pressure Switch <sup>3</sup>	Input Status 153	R	0=Open Switch 1=Closed Switch		
Blocked Inlet Pressure Switch <sup>3</sup>	Input Status 154	R	0=Open Switch 1=Closed Switch		
Low Gas Pressure Switch <sup>3</sup>	Input Status 155	R	0=Open Switch 1=Closed Switch		
Primary Probe ECO Status	Input Status 156	R	0=Open Switch 1=Closed Switch		
Flame Sensed	Input Status 228	R	0=No Flame 1=Flame Sensed		
MXi Low Temperature	Input Status 237	R	0=Temp OK 1=Low Temp		

1. Data is Version encoded into the upper 8 bits and Revision (Lower 8 bits).
2. This limits modulation to maximum EMS Percent Commanded. 100% = Allow up to rated firing (faster recovery). 0% = minimum modulation rate more efficient but has a slower recovery rate i.e. derates heater capacity).
3. MXi only: Due to hardware design MXi cannot detect switch state when in fault condition and will read 0. In standby any switch of lower in the limit string than an open switch above it will also appear open. Limit string order is Low Gas Pressure, Blocked Exhaust, Blocked intake and Blower prove.
4. Data stored in two 16 bit registers "Big Endian" (Higher order bits in lower register number)
5. Hours and Days used together derived from Time (hours x 100). i.e. Elapsed Time of 13612.24 hours in "Days" and "Hours" = 567 days, 4 hours.

**Modbus / Gas Water Heaters**

**Table 38. ModBus Gas Water Heaters Register List**

<b>Register Name (Description)</b>	<b>Register Type Address</b>	<b>R/W</b>	<b>Units</b>	<b>Min Value (if W)</b>	<b>Max Value (if W)</b>
MXi Leak Detected	Input Status 238	R	0=No Leak 1=Leak Detected		
MXI Heater Enable Switch	Input Status 239	R	0=Enable switch On 1=Disabled		
MXI External Enable	Input Status 240	R	0=Enable switch On 1=Disabled		
Xi 1.0 Igniter Current	Input Register 1043	R	mA		
Xi 1.0 External Vent Relay	Input Status 163	R	0=Open 1=Closed		
Xi 1.0 Blower Relay	Input Status 165	R	0=Open 1=Closed		
Gas Valve Relay	Input Status 166	R	0=Open 1=Closed		
Number of Cycles <sup>4</sup>	Input Registers 1000 - 1001	R			
Elapsed Time <sup>4</sup>	Input Registers 1002 - 1003	R	Hours x 100		
Elapsed Days <sup>5</sup>	Input Register 1004	R	Days		
Elapsed Hours <sup>5</sup>	Input Register 1005	R	Hours		
Heating Time <sup>4</sup>	Input Registers 1006 -1007	R	Hours x 100		
Heating Days <sup>5</sup>	Input Register 1008	R	Days		
Heating Hours <sup>5</sup>	Input Register 1009	R	Hours		
CCB Hardware Fault Counter	Input Register 53	R			
Xi 1.0 Model Fault Counter	Input Register 54	R			
Primary Temperature Fault Counter	Input Register 55	R			
Secondary Temperature Fault Counter	Input Register 66	R			
Communication Fault Counter	Input Register 69	R			
ECO Fault Counter	Input Register 70	R			
Low Gas Pressure Fault Counter	Input Register 71	R			
Blocked Inlet Fault Counter	Input Register 72	R			
Blocked Exhaust Fault Counter	Input Register 73	R			
Xi 1.0 External Vent Fault Counter	Input Register 74	R			
Blower Prove Fault Counter	Input Register 75	R			
Xi 1.0 Igniter Fault Counter	Input Register 77	R			
Ignition Failure Fault Counter	Input Register 78	R			
Power Supply Fault Counter	Input Register 79	R			
Powered Anode Fault Counter	Input Register 83	R			

1. Data is Version encoded into the upper 8 bits and Revision (Lower 8 bits).
2. This limits modulation to maximum EMS Percent Commanded. 100% = Allow up to rated firing (faster recovery). 0% = minimum modulation rate more efficient but has a slower recovery rate i.e. derates heater capacity).
3. MXi only: Due to hardware design MXi cannot detect switch state when in fault condition and will read 0. In standby any switch of lower in the limit string than an open switch above it will also appear open. Limit string order is Low Gas Pressure, Blocked Exhaust, Blocked intake and Blower prove.
4. Data stored in two 16 bit registers "Big Endian" (Higher order bits in lower register number)
5. Hours and Days used together derived from Time (hours x 100). i.e. Elapsed Time of 13612.24 hours in "Days" and "Hours" = 567 days, 4 hours.

**Central Control Board Major State Definitions**

<b>Table 39. Gas Central Control Board (CCB) Major State Definitions</b>		
<b>Value</b>	<b>Xi 1.0 State</b>	<b>MXi State</b>
1	Off (Standby)	Off (Standby)
2	Pre-Purge	Pre-Purge
3	Igniter Warmup	Igniting
4	Ignition Activation	Gas Valve On
5	Ignition Verification	Inter-Purge
6	Inter-Purge	Heating
7	Heating	Post-Purge
8	Post-Purge	In Fault
9	Fault	

**Xi 1.0 Energy Management System (EMS) Control**

Xi 1.0 uses a single bit setting method. Within the EMS Mode-Status point one bit command (bit 15) sets it in EMS mode, and other ends EMS mode. Once in EMS mode, another bit command (bit 0) enables heating another disables heating.

Once in EMS mode the EMS Mode Refresh command must be periodically issued which clears a third bit (bit 14) to maintain EMS mode, otherwise the heater will end EMS mode and resume normal operation.

<b>Table 40. Xi 1.0 Energy Management System (EMS) Control</b>			
<b>Decimal</b>	<b>Hex</b>	<b>Value</b>	<b>Response</b>
3840	0x0F00	No EMS control	0 / 0x000
3841	0x0F01	Put into EMS Mode <sup>^</sup>	49152 / 0xC000
0000	0x0000	EMS Disable heating <sup>^</sup>	49152 / 0xC000
0001	0x0001	EMS Enable heating <sup>^</sup>	49153 / 0xC001
3584	0x0E00	EMS Mode Refresh <sup>^</sup> (must write within 30 seconds or EMS mode ends.) 15 seconds or less recommended	49152 / 0xC000 or 49153 / 0xC001 depending on whether or not heating is enabled.

**Notes:**

- The start of a heating also depend on other factors like tank temperature dropping below Setpoint – Differential and External T'stat call for heat if that option is enabled.
- Depending on when you poll the register, you may read bit 14 as 1 which is why a "C" (in hexadecimal form) might briefly reply with "8". This is due to the control setting this bit and if it not cleared periodically by the BACnet command, heating is disabled.
- After disabling EMS mode with write of 3840, read back might have bits 14 and 1 possibly still set. To make sure these bits are clear, write a 0000 to clear bit 1 and 3584 to clear bit 14.

**Mxi Energy Management System (EMS) Control**

Mxi EMS control is written as a single command to place in EMS mode and enable or disable heating.

Once in EMS mode the EMS Mode Refresh command must be periodically issued to maintain EMS mode, otherwise the heater will end EMS mode and resume normal operation.

<b>Table 41. Mxi Energy Management System (EMS) Control</b>			
<b>Decimal</b>	<b>Hex</b>	<b>Value</b>	<b>Response</b>
0	0x0000	No EMS control~	0 / 0x000
32768	0x8000	EMS Disable Heating <sup>^</sup>	49152 / 0xC000
32769	0x8001	EMS Enable Heating <sup>^*</sup>	49153 / 0xC001

**Notes:**

- ~ For Versions less than 3.16, once EMS control mode is enabled it remains enabled through BACnet it will remain in EMS control mode that cannot be cleared by writing a 0 to it. Power cycling only can clear EMS mode.
- <sup>^</sup> Depending on when you poll the register, you may read bit 14 as 1 which is why a "C" (in hexadecimal form) might briefly reply with "8". This is due to the control setting this bit and if it not cleared periodically by the BACnet command, heating is disabled.
- <sup>\*</sup> EMS command to heat must be sent every 30 maximum or heating will be disabled.

**Fault Codes and Warnings**

**Note:** Any Fault not listed is an internal CCB failure fault.

Table 42. Fault Codes and Warnings				
Index Range (Decimal)		Index Range (Hex Code)		Value
0	0	0x000	0x000	Okay (No Fault)
1	6	0x001	0x006	Memory
24		0x018		Incorrect Model
51	56	0x033	0x038	Power Monitor
69	72	0x045	0x048	Temperature Probe Open or Short
153	154	0x099	0x09A	Communications Fault
165		0x0A5		High temperature ECO (Energy Cut Off)
175		0x0AF		Safety Relay Closed fault
176	188	0x0B0	0x0BC	CCB internal errors
193	194	0x0C1	0x0C2	Processor Clock
198	201	0x0C6	0x0C9	Non-volatile Memory
204	217	0x0CD	0x0D9	Powered Anode
431		0x1AF		Safety Relay Opened fault
1037	1037	0x40D		Element Open Warning

MODBUS / ELECTRIC WATER HEATERS



Figure 39. Custom and Gold Xi™ Series Electric Water Heaters (Virtual Modbus device via ICC Gateway)

**PRODUCT DESCRIPTION**

Commercial Electric water heaters are designed for commercial hot water applications. The controls provide easy to read, plain English configuration and diagnostics. All electronic controls provide communications via propriety protocol with the ICC Gateway. The Mirius supports Modbus RTU communications and the ETH-1000 supports Modbus/TCP to access data available at the display plus control of a limited number of points such as Operating Setpoint.

**ELECTRIC WATER HEATER REGISTER LISTINGS**

**Modbus Electric Water Heaters Register Properties**

- Not all models support all registers. Also parameter names may be different those shown here on some models.
- This table may be subject to change in the future.
- Adjustable objects are in bold and indicated by “W” (writable).

Table 43. ModBus / Electric Water Heaters Register List					
Register Name (Description)	Register Type	R/W	Units/Format	Min Value (if W)	Max Value (if W)
Firmware Ver-Rev <sup>1</sup> (Firmware Version)	Input Register 1	R			
Configuration	Input Register 2	R			
Tank Temperature (Controlling (Tank) Temperature)	Input Register 6	R	°C x 512		
<b>Setpoint Temperature</b>	Holding Register 6	R/W	°C x 512 (°F)	32.2 (90)	87.7 (190)
<b>Differential Bank 1</b>	Holding Register 207	R/W	°C x 512 (°F)	.6 (1)	11.1 (20)
<b>Differential Bank 2</b>	Holding Register 208	R/W	°C x 512 (°F)	.6 (1)	11.1 (20)

1. Data is Version (upper 8 bits) and Revision (lower 8 bits).  
 2. Data stored in two 16 bit registers “Big Endian” (Higher order bits in lower register number)  
 3. Hours and Days used together derived from Time (hours x 100) i.e. Elapsed Time of 13612.24 hours in “Days” and “Hours” = 567 days, 4 hours.

**Modbus / Electric Water Heaters**

**Table 43. ModBus / Electric Water Heaters Register List**

Register Name (Description)	Register Type	R/W	Units/Format	Min Value (if W)	Max Value (if W)
Differential Bank <sup>3</sup>	Holding Register 209	R/W	°C x 512 (°F)	.6 (1)	11.1 (20)
Differential IBank <sup>4</sup>	Holding Register 210	R/W	°C x 512 (°F)	.6 (1)	11.1 (20)
Differential Bank <sup>5</sup>	Holding Register 211	R/W	°C x 512 (°F)	.6 (1)	11.1 (20)
CCB Control State	Input Register 1040	R	See <i>Table 44.</i>		
EMS Mode-Status	Holding Register 90	R/W	See <i>Table 45.</i>		
Fault Code	Input Register 1041	R	See <i>Table 46.</i>		
Alert Code	Input Register 1042	R	See <i>Table 46.</i>		
Number of Banks in Heater	Input Register 201	R			
Number of Banks Commanded On	Input Register 213	R			
Bank 1 Status	Input Status 3873	R	0=Off 1=On		
Bank 2 Status	Input Status 3874	R	0=Off 1=On		
Bank 3 Status	Input Status 3875	R	0=Off 1=On		
Bank 4 Status	Input Status 3876	R	0=Off 1=On		
Bank 5 Status	Input Status 3877	R	0=Off 1=On		
Element Status	Input Register 219	R	Bit 0=Element 1 Bit 1=Element 2 . . Bit 14=Element 14		
Tank Full (LWCO)	Input Status 150	R	0=Open Switch 1=Closed Switch		
AC Input 1 T'stat	Input Status 3428	R	0=Open 1=Closed		
AC Input 2 T'stat	Input Status 3429	R	0=Open 1=Closed		
Alarm Condition	Input Status 3441	R	0=Open 1=Closed		
Alarm Relay Status	Input Status 3443	R	0=Open 1=Closed		
Safety Relay Feedback	Input Status 147	R	0=Open 1=Closed		
Temperature Probe Open	Input Status 65	R	0=False 1=True		
Temperature Probe Short	Input Status 66	R	0=False 1=True		
Temperature Probe ECO Status	Input Status 156	R	0=Open 1=Closed		
Number of Cycles <sup>2</sup>	Input Registers 1000 - 1001	R			
Elapsed Time <sup>2</sup>	Input Registers 1002 - 1003	R	Hours x 100		
Elapsed Days <sup>3</sup>	Input Register 1004		Days		
Elapsed Hours <sup>3</sup>	Input Register 1005		Hours		
Heating Time <sup>2</sup>	Input Registers 1006 - 1007		Hours x 100		
Heating Days <sup>3</sup>	Input Register 1008	R	Days		

1. Data is Version (upper 8 bits) and Revision (lower 8 bits).

2. Data stored in two 16 bit registers "Big Endian" (Higher order bits in lower register number)

3. Hours and Days used together derived from Time (hours x 100) i.e. Elapsed Time of 13612.24 hours in "Days" and "Hours" = 567 days, 4 hours.



<b>Table 43. ModBus / Electric Water Heaters Register List</b>					
<b>Register Name (Description)</b>	<b>Register Type</b>	<b>R/W</b>	<b>Units/Format</b>	<b>Min Value (if W)</b>	<b>Max Value (if W)</b>
Heating Hours <sup>3</sup>	Input Register 1009	R	Hours		
Bank 1 Number of Heat Cycles <sup>2</sup>	Input Registers 1030 - 1031	R			
Bank 2 Number of Heat Cycles <sup>2</sup>	Input Registers 1032 - 1033	R			
Bank 3 Number of Heat Cycles <sup>2</sup>	Input Registers 1034 - 1035	R			
Bank 4 Number of Heat Cycles <sup>2</sup>	Input Registers 1036 - 1037	R			
Bank 5 Number of Heat Cycles <sup>2</sup>	Input Registers 1038 - 1039	R			
Bank 1 Heating Time <sup>2</sup>	Input Registers 1010 - 1011		Hours x 100		
Bank 1 Heating Days <sup>3</sup>	Input Register 1012	R	Days		
Bank 1 Heating Hours <sup>3</sup>	Input Register 1013	R	Hours		
Bank 2 Heating Time <sup>2</sup>	Input Registers 1014 - 1015	R	Hours x 100		
Bank 2 Heating Days <sup>3</sup>	Input Register 1016	R	Days		
Bank 2 Heating Hours <sup>3</sup>	Input Register 1017	R	Hours		
Bank 3 Heating Time <sup>2</sup>	Input Registers 1018 - 1019	R	Hours x 100		
Bank 3 Heating Days <sup>3</sup>	Input Register 1020	R	Days		
Bank 3 Heating Hours <sup>3</sup>	Input Register 1021	R	Hours		
Bank 4 Heating Time <sup>2</sup>	Input Registers 1022 - 1023	R	Hours x 100		
Bank 4 Heating Days <sup>3</sup>	Input Register 1024	R	Days		
Bank 4 Heating Hours <sup>3</sup>	Input Register 1025	R	Hours		
Bank 5 Heating Time <sup>2</sup>	Input Registers 1026 - 1027	R	Hours x 100		
Bank 5 Heating Days <sup>3</sup>	Input Register 1028	R	Days		
Bank 5 Heating Hours <sup>3</sup>	Input Register 1029	R	Hours		
CCB Hardware Fault Counter	Input Register 53	R			
Module Fault Counter	Input Register 54	R			
Temperature Probe Fault Counter	Input Register 55	R			
CCB Communication Fault Counter	Input Register 69	R			
ECO Fault Counter	Input Register 70	R			
LWCO (Low Water Cutoff) Fault Counter	Input Register 80	R			
Powered Anode Fault Counter	Input Register 83	R			
Element Banks Used	Input Register 201	R			
Element Fault Counter	Input Register 242	R			
Elements in Bank 1	Input Register 202	R			
Elements in Bank 2	Input Register 203	R			
Elements in Bank 3	Input Register 204	R			
Elements in Bank 4	Input Register 205	R			
Elements in Bank 5	Input Register 206	R			

1. Data is Version (upper 8 bits) and Revision (lower 8 bits).

2. Data stored in two 16 bit registers "Big Endian" (Higher order bits in lower register number)

3. Hours and Days used together derived from Time (hours x 100) i.e. Elapsed Time of 13612.24 hours in "Days" and "Hours" = 567 days, 4 hours.

## Modbus / Electric Water Heaters

### Central Control Board Major State Definitions

Table 44. ModBus / Electric Water Heaters Central Control Board (CCB) State	
Value	State
0	Off (Standby)
6	Heating
8	Fault

### Energy Management System (EMS) Control

Commercial Electric water heaters with Xi controls use a single bit setting method. Within the EMS Mode-Status point, one bit command (bit 15) sets it in EMS mode, and other ends EMS mode. Once in EMS mode, another bit command (bit 0) enables heating; another disables heating.

Once in EMS mode the EMS Mode Refresh command must be periodically issued which clears a third bit (bit 14) to maintain EMS mode, otherwise the heater will end EMS mode and resume normal operation.

Table 45. ModBus /Electric Water Heaters Energy Management System (EMS) Control			
Decimal	Hex	Value	Response
3840	0x0F00	No EMS control	0 / 0x000
3841	0x0F01	Put into EMS Mode <sup>^</sup>	49152 / 0xC000
0000	0x0000	EMS Disable heating <sup>^</sup>	49152 / 0xC000
0001	0x0001	EMS Enable heating <sup>^</sup>	49153 / 0xC001
3584	0x0E00	EMS Mode Refresh <sup>^</sup> (must write within 30 seconds or EMS mode ends.) 15 seconds or less recommended	49152 / 0xC000 or 49153 / 0xC001 depending on whether or not heating is enabled.

NOTE:

The start of a heating cycle also depends on other factors, like *Tank Temperature* dropping below Setpoint – Differential and *External T'stat Call for Heat* if that option is enabled.

<sup>^</sup>Depending on when you poll the register, you may read bit 14 as 1, which is why a “C” (in hexadecimal form) might briefly reply with “8”. This is due to the control setting this bit and if it not cleared periodically by the Modbus command, heating is disabled.

After disabling EMS mode with write of 3840, read-back might have bits 14 and 1 possibly still set. To make sure these bits are clear, write a 0000 to clear bit 1 and 3584 to clear bit 14.

### Fault Codes and Warnings

**Note:** Any Fault not listed is an internal CCB failure fault.

Table 46. BACnet/Electric Water Heaters Fault Codes and Warnings				
Index Range (Decimal)		Index Range (Hex Code)		Value
0	0	0x000	0x000	Okay (No Fault)
1	6	0x001	0x006	Memory
24		0x018		Incorrect Model
51	56	0x033	0x038	Power Monitor
69	72	0x045	0x048	Temperature Probe Open or Short
153	154	0x099	0x09A	Communications Fault
165		0x0A5		High temperature ECO (Energy Cut Off)
175		0x0AF		Safety Relay Closed fault
176	188	0x0B0	0x0BC	CCB internal errors
193	194	0x0C1	0x0C2	Processor Clock
198	201	0x0C6	0x0C9	Non-volatile Memory
205	217	0x0CD	0x0D9	Powered Anode
431		0x1AF		Safety Relay Opened fault
1037	1037	0x40D		Element Open Warning

## ICC PROGRAM INFORMATION

For programming information or model compatibility contact:

The Electronics Group at 888-928-3702 select option 1 (this will ring on the iCOMM line).



Copyright © 2020. All rights reserved.

[www.hotwater.com](http://www.hotwater.com) | 800-527-1953 Toll-Free USA |  
500 Tennessee Waltz Parkway  
Ashland City, TN 37015